

BACK BAR

Back Bar Refrigerator

Models:

BC-1DSW-SS, BC-1DSW-BK, BC-2DSL-BK,
BC-2DSW-BK, BC-3DSW-BK

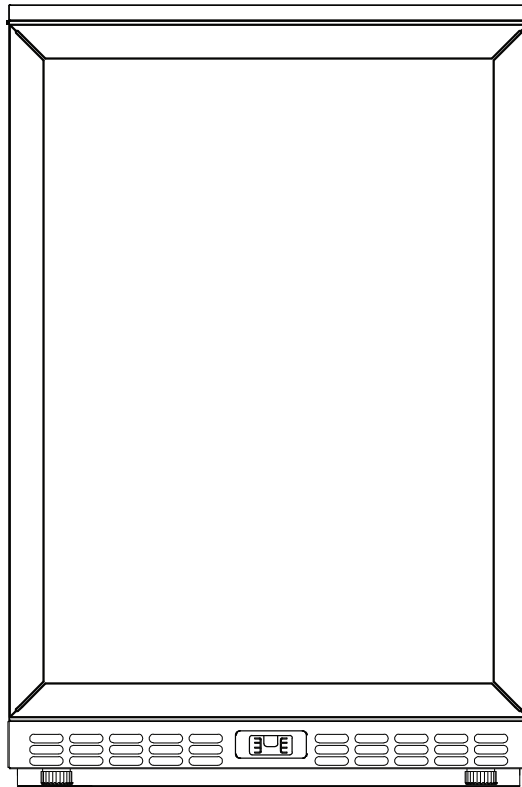

Before using, please read the operating instructions carefully to ensure proper application and achieve satisfactory results.

SAFETY PRECAUTIONS

- To ensure proper use, please thoroughly study these SAFETY PRECAUTIONS before operating the Unit.
- The purpose of the safety precautions in this manual is to ensure safe and correct use of the unit to minimize risks that could cause serious damage and injury to you or other persons. The safety precautions are divided into WARNINGS and CAUTIONS. Cases where improper handling of the unit could lead to death or serious injury are listed under the "⚠️WARNING" heading. However, the cases listed under the "⚠️CAUTION" heading could also lead to serious results. To ensure the safety, adhere strictly to both types of safety precautions.
- Keep ventilation openings, in the appliance enclosure or in the built-in structure, clear of obstruction.
- This appliance is not intended for use by persons (including children) with reduced physical, sensory or mental capabilities, or lack of experience and knowledge, unless they have been given supervision or instruction concerning use of the appliance by a person responsible for their safety.
- Children should be supervised to ensure that they do not play with the appliance.
- Do not use mechanical devices or other means to accelerate the defrosting process, other than those recommended by the manufacturer.
- Do not damage the refrigerant circuit.



WARNING Improper handling of the unit could lead to death or serious injury.



CAUTION Improper handling of the unit could lead to serious results depending on the circumstances.

- Text set off by the exclamation mark ⚠️ contains information that should be strictly adhered to.
- After reading the instruction manual, store it in an easily accessible place where the user(s) of this product can easily find it.

◆ PRECAUTIONS FOR INSTALLATION

⚠️ WARNING



Installation should be performed only by the dealer or a qualified expert. Attempting to install the unit yourself could result in water leakage, refrigerant leakage, electrical shock, or fire.

◆ PRECAUTIONS FOR USE

⚠️ WARNING



DONT TAMPER

All repairs, disassembly and modifications should be performed only by qualified technicians. Attempting to perform these yourself could result in a fire, malfunction, and injury.

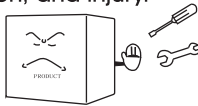

ELECTRICAL SHOCK HAZARDS

Never splash water directly onto the product or wash with water as short-circuit and electrical leakage could result.

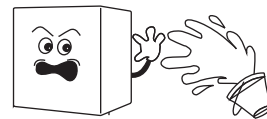

DANGER OF EXPLOSION

Never put flammable or volatile substances into the unit as explosion and fire could result.

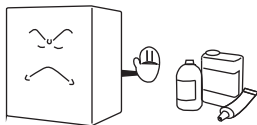

PROHIBITED

Do not damage, modify, excessively bend, strain, twist or bundle up the power cord. Also, placing heavy objects on the power cord or squeezing it in a tight place could damage it, possibly resulting in electrical shock or fire.

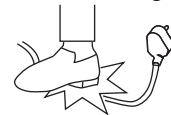

PROHIBITED

Use a dedicated wall outlet. Do not use extension cords or convenience receptacles as this could result in electrical shock, overheating and a fire.

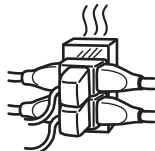

FLAMMABLE

Never use flammable spray cans or leave flammable substances near the unit. Sparks from electrical switches could result in explosion and fire.

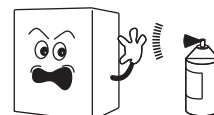

SAFETY PRECAUTIONS

! WARNING



The cooler is intended for storage and display of beverages for sale. Do not use for other purpose than intended as this could adversely affect items placed in the unit.

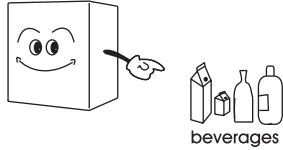

Never attempt to insert fingers, sticks, etc. into the cold air suction outlet as a circulation fan is rotating at high speed inside the outlet. Injury, electrical shock and improper operation could result.

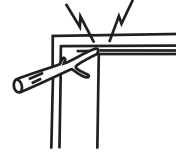

PROHIBITED

For indoor use only. Using the unit in a location exposed to rain could result in electrical leakage and electrical shock.

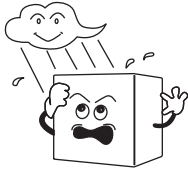

PROHIBITED

Never place heavy objects or items containing water on top of the unit. Objects could fall down and cause injury and spilled water could deteriorate the insulation of electrical components and result in electrical leakage.

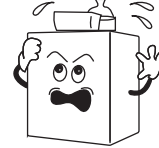

Install the unit in a location where the floor is sturdy enough to support the load of the unit. If the floor is not sturdy enough or installation is incorrectly performed, the unit could tip over and falling shelves and products could cause personal injury.

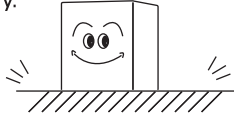

CAUTION AGAINST EXPLOSION

If you find gas leakage, please don't touch the chest freezer, and close gas and open the door for ventilation. Gas leakage could cause explosion, fire, and fire injury.

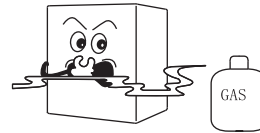

Store the unit in a location where it is not exposed to rain. Using a unit that has been exposed to rain could result in electrical leakage and electrical shock.

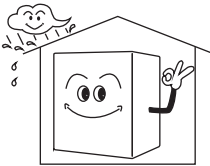

Keep away from hot air sources
Cooling performance is reduced if the unit is placed near heat sources such as hot plates and stoves and if it is exposed to direct sunlight.



Leave disassembly and disposal of the unit to qualified experts.

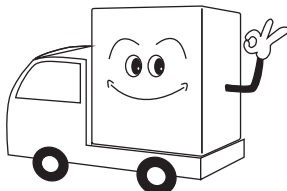

Should the unit need temporary storage, make sure not to store the unit in a location where children play and take precautions so that the door cannot be completely closed. This will minimize the risk that a child becomes trapped inside the compartment.

SAFETY PRECAUTIONS

! WARNING

WELL VENTILATED PLACE

Please make sure there is more than 10cm space between UPRIGHT COOLER and the wall. If there is no space, cooling capacity can drop down.

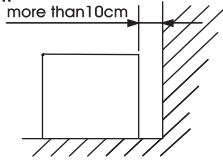

If installation in a damp location is unavoidable, also install an electrical leakage circuit breaker. If no electrical leakage circuit breaker is installed, electrical shock could result.

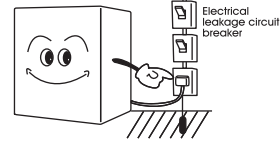

Never hang from the door or climb onto the unit. The unit could tip over or fall and cause material damage or injury.

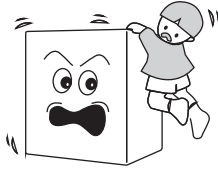

Disconnect the power cord plug from the wall outlet before moving the unit and make sure that the power cord is not damaged during transport. A damaged power cord could result in electrical shock and/or fire.

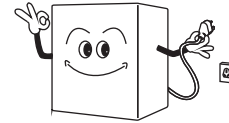

Grasp the handle when closing the door. Holding at other positions could result in pinched fingers and injury.



Do not push hand against or apply excessive force to glass surfaces as the glass could break and cause injury.



When disconnecting the power cord plug from the wall outlet, hold at the plug main body close to the outlet. Pulling the cord could cause wire breakage, possibly resulting in overheating and fire.

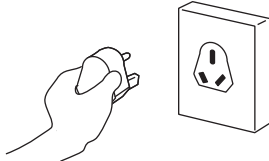

Make sure that the unit does not tip over or fall when it is moved. A falling unit could cause serious injury.

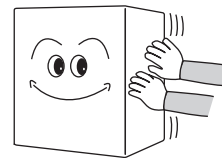

Do not throw items onto the shelves and do not place items totaling more than 65lbs on each shelf. The shelf could fall down, possibly causing injury.



Be sure to attach and secure shelves correctly. An improperly attached shelf could fall down and cause injury.

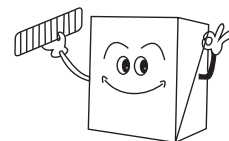

HOW TO USE

BEFORE USE

- Remove shipping package, tape, etc, and leave doors open ventilate for a while.
- The unit is cleaned before shipment. However, clean the compartment interior after delivery.
- Please insert power supply plug into the wall outlet ,single-phase to cat voltage.
- Allow the unit to operate for about 1 hour to cool the compartment before placing items in the cooler.

WAIT 5 MINUTES OR MORE BEFORE RE-STARTING

- Restarting the unit immediately after it has been turned off may cause fuses to blow and activate the circuit-breaker, the compressor may be overloaded, and/or other damage may occur.

CONTROLS

- The thermostat control is located below the doors on the front of the appliance
- Refrigeration is switched on and off at the mains supply.
- The light is controlled independently by using the toggle switch provided at the front of the unit.

Warning: If the supply cord is damaged, the manufacturer, its service agent or similarly qualified person must replace it, in order to avoid a hazard.

CIRCUIT DIAGRAM

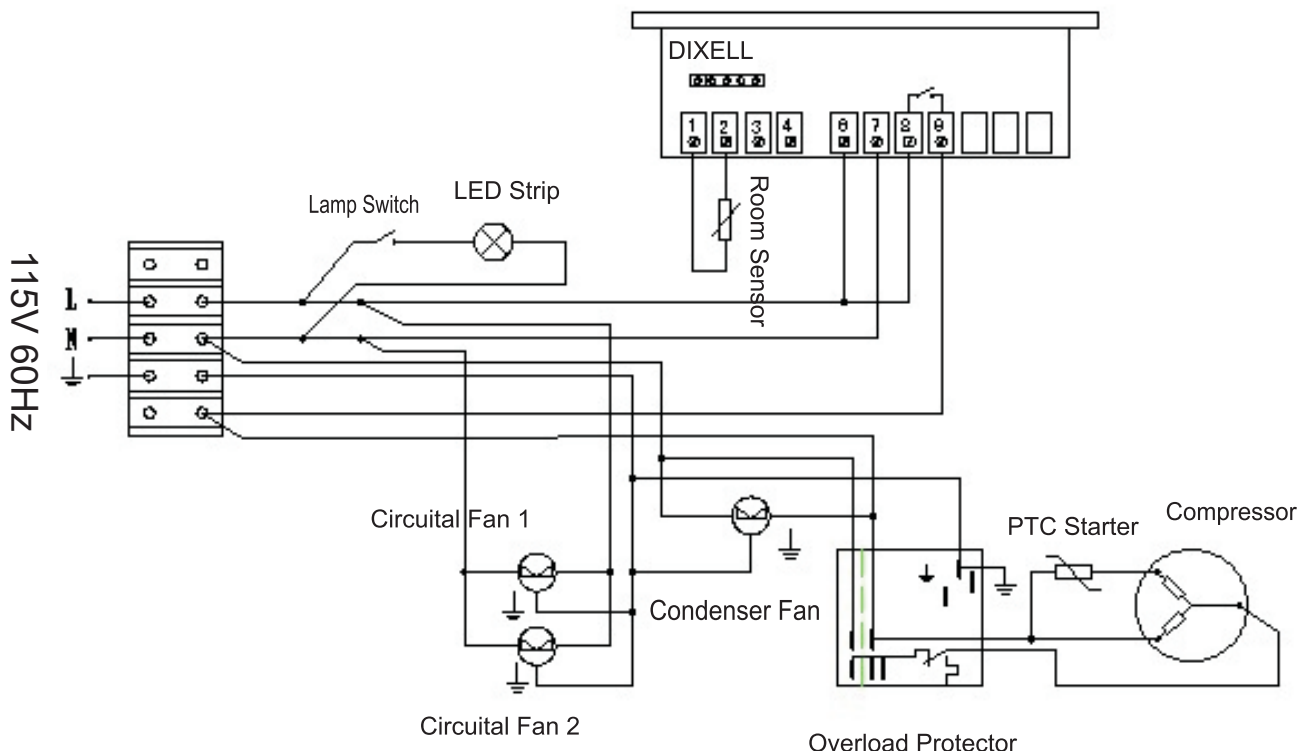

HOW TO USE

DRAIN TRAY

- Defrosting is performed automatically and drain water is collected in the drain tray.
- Water in the drain tray is evaporated automatically. In humidity, there is a large amount of water in the drain tray, so please throw away drain water once a day.

EFFICIENT USE

- To prevent cold air from escaping, open and close the door quickly and keep the door opened for as short a time as possible.
- Please install the unit in the place which is well-ventilated.

SHELF HEIGHT ADJUSTMENT

The shelf height can be adjusted.

Arrange the shelves in accordance with the dimensions of the items to be placed in the cooler.

PLACING ITEMS IN THE SHOWCASE

This showcase employs a forced circulation of cold air system. If circulation of cold air is obstructed, the items will not be adequately refrigerated. Pay attention to the following points:

- Do not let items obstruct the cold air inlet and suction outlet.
 - Place items so that they do not protrude from the shelves. The gap between the shelves and the door is used for circulation of cold air.
 - Place items evenly on all shelves.
- Please do not display goods on the bottom. Please put goods on the shelf.
Commercial refrigeration display cooler.

INSTRUCTION MANUAL

CLEANING



WARNING

To prevent any electrical shock hazards or injury by rotating circulation fan, always disconnect the power cord plug from the wall outlet before cleaning.

1 EXTERIOR AND COOLER COMPARTMENT

Wipe with a soft, dry cloth. If very soiled, wipe with a cloth that has been moistened with a detergent. Then wipe with a cloth that has been dipped in water.



WARNING

WARNING: Do not splash water directly onto the cooler and do not wash with water. Short-circuit and electrical shock could result.

- Clean the cooler regularly to keep it clean at all times.
- Never use polishing powder, soap powder, benzene, oil or hot water as these will damage the painting and plastic components.

2 CHECKS

To ensure the safety, perform the following checks after cleaning.

- Is the power cord plug firmly inserted into a dedicated wall outlet? Confirm that the plug is not abnormally hot.
- Check the power cord for cracks and damage. Should the slightest irregularity be observed, contact the dealer from whom you purchased this unit or our customer's service.

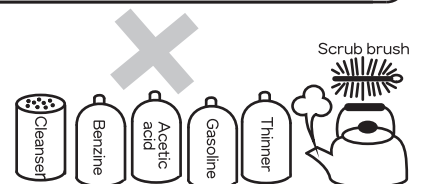

IN CASE OF THE FOLLOWING

1 POWER FAILURE

Keep opening and closing of the door to a minimum.
Avoid placing new items in the cooler as this will raise the temperature inside the compartment.

2 WHEN NOT USED FOR A LONG PERIOD

Remove all items from the compartment and disconnect the power cord plug from the wall outlet.
Clean the compartment interior and wipe away all water.
To prevent mold formation and bad smell, leave the door open to dry the compartment completely.

3 TRANSPORTATION

Disconnect the power cord plug from the wall outlet.
When moving the cooler, make sure that the feet do not damage the power cord.
Do not let the feet hit against floor steps, thresholds, etc.

4 TEMPORARY STORAGE

Affix a piece of wood, etc. Between the door and main unit to prevent complete closing of the door.
Make sure not to store the unused cooler at a location where children play.
Should a child enter the compartment and the door is closed, the child may not be able to open the door from the inside.

INSTRUCTION MANUAL

BEFORE REQUESTING SERVICE

Please check the following items if you encounter problems with the unit. If the problem continues after taking the proper remedial actions, disconnect the power cord plug from the wall outlet. Transfer the items stored in the cooler to a box or other container. Then contact the dealer from whom you purchased this unit and be ready to provide information as listed in "REQUIRED INFORMATION" below.



To prevent any electrical shock hazards, do not disconnect the power cord plug from the wall outlet with wet hands.

BEFORE REQUESTING SERVICE

Fault	Probable Cause	Action
The appliance is not working	The unit is not switched on	Check the unit is plugged in correctly
	Plug and lead are damaged	Call your agent or qualified technician
	Fuse in the plug has blown	Replace the fuse (UK Plug)
	Power supply	Check power supply
	Internal wiring fault	Call your agent or qualified technician
The appliance turns on, but the temperature is too high/ low	Too much ice on the evaporator	Defrost the appliance
	Condenser blocked with dust	Call your agent or qualified technician
	Doors are not properly	Check doors are shut and seals are not damaged
	Appliance is located near a heat source or air flow to the condenser is being interrupted	Move the refrigerator to a more suitable location
	Ambient temperature is too high	Increase ventilation or move appliance to a cooler position
	Appliance is overloaded	Reduce the amount of containers in the appliance
The appliance is unusually loud	Loose nut/ screw	Check and tighten all nuts and screws
	The appliance has not been installed in a level or stable position	Check installation position and change if necessary
The appliance is leaking water	The appliance is not properly leveled	Adjust the screw feet to level the appliance
	The discharge outlet is blocked	Clear the discharge outlet
	The water container is damaged	Call your agent or qualified technician

Showcase sometimes stop running when thermostat turns off.

INSTRUCTION MANUAL

REQUIRED INFORMATION

- | | |
|--|---|
| ① Nature of malfunction
(as accurately as possible) | ④ Customer's name, address,
phone number |
| ② Product number | ⑤ Year and date of purchase |
| ③ Serial number | ⑥ Desired date for service visit |
- } ON RATING LABEL
ON CARTON



WARRANTY

LIMITED WARRANTY

LIMITED WARRANTY KOOLMORE SUPPLY, INC. warrants to the original consumer or purchaser this KOOLMORE product is free from defects in material or workmanship for a period of One (1) year from the date of purchase. If any such defect is discovered within the warranty period, KOOLMORE SUPPLY, INC., at its discretion, will repair or replace the product at no cost or pay for replacement parts and repair labor to correct defects in materials or workmanship that existed when this major appliance was purchased or that are the result of normal usage when this major appliance is installed, operated and maintained according to instructions attached to or furnished with the product, At its sole discretion. Koolmore Supply Inc may determine to replace the product. In the event of product replacement, your appliance will be warranted for the remaining term of the original unit's warranty period.

This limited warranty is good only to the original purchaser of the product and effective only when used in the United States.

This limited warranty is effective from the date of original consumer purchase. Proof of original purchase date is required to obtain service under this limited warranty.

YOU'RE SOLE AND EXCLUSIVE REMEDY UNDER THIS LIMITED WARRANTY SHALL BE PRODUCT REPAIR AS PROVIDED HEREIN.

Service must be provided by a Koolmore designated service company.

For warranty or repair service: Email us at support@koolmore.com include your name, address, phone number, warranty repair request, and a copy of your proof of purchase receipt.

You can also visit us at koolmore.com and use the contact us page.

KOOLMORE customer service will contact you and arrange prompt service for your appliance.

Thank you for choosing KOOLMORE.

THIS LIMITED WARRANTY DOES NOT APPLY TO

- 1.Failure of product to perform during power failures and interruptions or inadequate electrical service
- 2.Damage caused by transportation or handling.
- 3.Damage caused to the product by accident, vermin, lightning winds, fire, floods, or acts of God.
- 4.Damage resulting from accident, alteration, misuse, abuse, or improper installation, repair, or maintenance. Improper use includes using an external device that alters or converts the voltage or frequency of electricity
- 5.Any unauthorized product modification, repair by unauthorized repair center, or use of non-approved replacement parts.
- 6.Abnormal cleaning and maintenance as described in the user's manual.
- 7.Use of accessories or components that are not compatible with this product.

The cost of repair or replacement under these excluded circumstances shall be borne by the consumer.

