



# USER MANUAL

# DISPLAY CASE

## Circular Refrigerated Countertop Bakery Display Case

Model:  
CDUR-3C

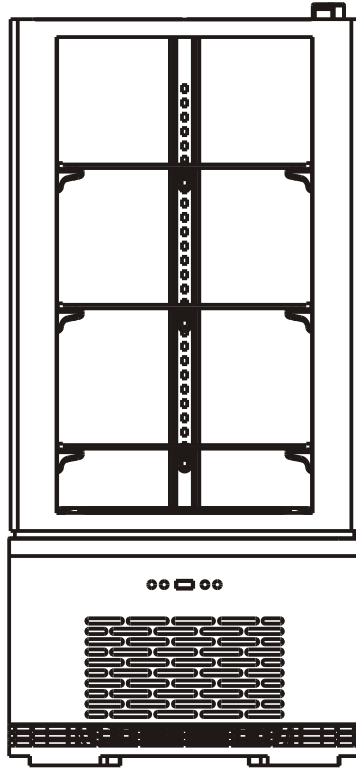

***Before using, please read the operating instructions carefully to ensure proper application and achieve satisfactory results.***

***For any service-related Issues, please contact us: Phone Number: 718-576-6342  
Email address: [support@koolmore.com](mailto:support@koolmore.com)***

## Contents

|  |    |
|--|----|
| General .....  | 1. |
| Structure and Parts .....  | 1. |
| Assembly and Care Instructions .....                                 | 2. |
| Preparation and Power Supply .....                                   | 3. |
| Usage and Precautions .....  | 4. |
| Digital Controller Troubleshooting .....                             | 5. |
| Maintenance .....  | 6. |
| Troubleshooting .....  | 6. |
| Principle of Refrigeration System and Electric Circuit Diagram ..... | 7. |
| Circuit Diagram.. .....  | 7. |
| Major Parameters .....   | 8. |
| Warranty.....  | 9. |

## General

1. The refrigerator utilizes a top brand fully enclosed compressor, featuring environmentally friendly refrigerants R290/R134a. The rational configuration of the refrigeration system along with forced-air cooling provides even temperature distribution inside the refrigerator.
2. The refrigerator is equipped with double hollow transparent glasses on the door and body, ensuring an artistic and elegant appearance, excellent visibility, and easy access.
3. This versatile refrigerator is suitable for use in department stores, homes, meeting rooms, and living areas.

## Structure and Parts



# Assembly and Care Instructions

## Handle with Care

Ensure to unplug the refrigerator from the wall socket prior to moving. Never tilt the refrigerator beyond a 45-degree angle while handling.

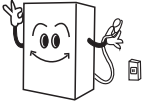

## Dry Location

Always position the refrigerator in a dry location.



## Ensure Sufficient Space

Maintain at least a 4-inch distance between the refrigerator's sides and back, and any walls or objects. This distance is crucial for proper air circulation. Insufficient space can impair the refrigerator's cooling ability.

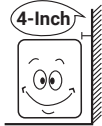

## Proper Ventilation

Place the refrigerator in a well-ventilated location. After relocating the refrigerator, allow it to stand unplugged for 2 hours before plugging it back into the wall socket for initial startup.

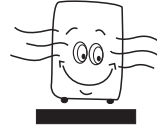

## Avoid Heat Sources

Position the refrigerator away from direct sunlight and other heat sources like heaters. Exposure to such conditions can negatively impact the refrigerator's cooling efficiency.

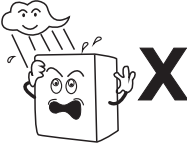

## Avoid Heavy Loads

Do not place heavy objects atop the refrigerator.

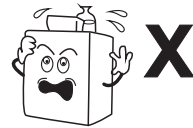

## No Modifications

Refrain from making any alterations, such as drilling holes or installing additional items, to the refrigerator.

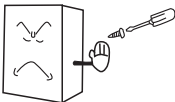

## Stable Placement

Carefully unpack the refrigerator and position it on a flat, stable surface. This precautionary measure will help prevent unwanted noise and vibrations.



# Preparation and Power Supply

## Dedicated Power Socket

The refrigerator should be powered by a 110-120V, 60Hz single-phase AC supply through a dedicated single-phase three-pin receptacle.



## Avoid Socket Sharing

The refrigerator should never share a common socket with other appliances to prevent overheating of the power cable, which could lead to a fire.

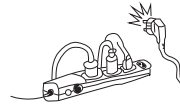

## Protect Cables

Ensure the power cables are not damaged or compromised to prevent electrical leakage and potential fire hazards.



## Avoid Water Exposure

Do not expose the refrigerator surface to water to avoid electrical leakage.



## Avoid Flammables and Explosives

Never store any flammable or explosive substances such as ether, gasoline, alcohol, adhesive, and explosives in the refrigerator. Avoid placing these dangerous substances near the refrigerator.



## No Spraying

Spraying of flammable substances such as paint or coatings near the refrigerator is prohibited, as it could lead to a fire

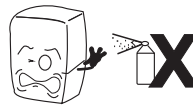

## After Power Interruption

Following a power interruption or after unplugging the refrigerator, wait at least 5 minutes before plugging in and restarting the refrigerator.



## Avoid Storing Medication

Do not store medication inside the refrigerator.



# Usage and Precautions

## 1. Initial Use

Plug the refrigerator into a 110-120V exclusive socket. Once the refrigerator starts running, Place your hand on the air suction area to verify it's cold enough before placing food in the cold box.

## 2. Digital Temperature Controller

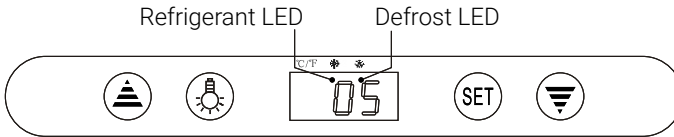

### A. Features:

The controller is mini-sized and intelligent, suitable for one Hp compressors. Its functions include: Temperature Display/Control, Manual and Automatic Defrost, Illumination Control, Value Storing, Self-Testing, and Parameter Locking.

### B. Front Panel Operations:

#### 01. Temperature Setting:

Press the "SET" button to display the set temperature. Use "▲" or "▼" buttons to adjust and store the temperature. Press "SET" again to exit and display the cold-room temperature.

#### 02. Display Default:

If no button is pressed within 10 seconds, the cold-room temperature will be automatically displayed.

#### 03. Lighting and Defrost Control:

Press "▲" button to control the light; hold it for 6 seconds to start or stop the defrost cycle.

#### 04. Refrigerant LED:

The LED is on during refrigeration and flashes when the cold room temperature is stable.

#### 05. Defrost LED:

The LED is on during defrosting and turns off when defrosting ends.

#### 06. Digital Controller Reset:

If the display shows "Disorder", press "▼" for 2 seconds until the buzzer rings. Quickly press "▲" for 6 seconds until the buzzer rings again. The display will flash for 3 seconds and the controller will reset to factory settings.

# Usage and Precautions

## 3. Safety Precautions

- Minimize the frequency and duration of door openings to maintain cold temperatures inside the refrigerator.
- Ensure the air suction and outlet are not obstructed for effective air circulation and refrigeration.
- Do not overload the refrigerator, as this may impact its cooling efficiency.
- Adjust the rack height according to the size of the food items stored.
- Allow hot food to cool to room temperature before storing it in the refrigerator.
- Limit the opening of the refrigerator to maintain its internal temperature in case of power failure.
- Only trained professionals should repair the power cable using appropriate tools.
- Avoid touching the compressor to prevent burns.
- If the supply cord is damaged, it must be replaced by qualified personnel to prevent hazards.
- Persons with physical, sensory, or mental impairments, as well as those lacking experience or knowledge, should only use this appliance under supervision.
- Children should not be allowed to play with the appliance.
- The user manual may not be suitable for those with physical, sensory, or mental impairments, or a lack of experience or knowledge.
- Do not store explosive substances such as aerosol cans with a flammable propellant in the refrigerator.
- The noise level during normal operation does not exceed 70dB(A).
- Do not exceed the maximum load limit of 18kg (39.7lbs) per shelf.
- The appliance operates best at ambient temperatures of 16°C-32°C (60.8°F-89.6°F).
- Avoid storing corrosive food to prevent damage.
- Ensure ventilation openings remain unobstructed.
- Avoid using mechanical devices or any other means to accelerate defrosting, unless recommended by the manufacturer.
- Avoid damaging the refrigerant circuit.
- Avoid using electrical appliances inside the food storage compartments unless recommended by the manufacturer.



### Additional Warning:

Risk of fire. The height of the triangle in this symbol must be at least 0.59 inches.

## Digital Controller Troubleshooting

| Fault Code | Cause  | Solution   |
|------------|--|--|
| EE1        | Open circuit or short circuit of temperature probe     | • Check if the plug on the mainboard is loose. If so, Secure it or replace the temperature probe if necessary.   |
| EE2        | Open circuit or short circuit of defrosting probe      | • Check if the plug on the mainboard is loose. If so, Secure it or replace the defrosting probe if necessary.  |
| EE3        | Open circuit or short circuit of the overheating probe | • Check if the plug on the mainboard is loose. If so, Secure it or replace the overheating probe if necessary.   |
| EE4        | Overheating probe initiates protective program 136.4°F | <ol style="list-style-type: none"><li>1. Condenser may have too much dust - Clean the condenser.</li><li>2. Condenser motor might have stopped working - Repair or replace the motor.</li><li>3. The unit might be too close to the wall - Maintain at least 50cm of space between the product and the wall.</li><li>4. Ambient temperature could be too high - Ensure the ambient temperature stays within the range specified on the rating label.</li></ol> |

## Maintenance

### 1. General Notice

Maintain the refrigerator's cleanliness with regular upkeep. Always unplug before maintenance. Avoid using a damaged plug or loose socket to prevent electric shocks or short circuits. Do not clean the refrigerator with water, alkali detergent, soap, gasoline, acetone, or a brush.

### 2. Cleaning the Exterior

Use a soft cloth dipped in neutral detergent (like dish soap) to clean the refrigerator's exterior. Follow up by wiping with a dry, soft cloth.

### 3. Cleaning the Interior

Remove the rack for water cleaning. Use a soft cloth to clean the interior of the refrigerator.

### 4. Extended Shutdown

If the refrigerator will be unused for a prolonged period, remove all food and unplug it from the wall socket. Thoroughly clean the interior and exterior, leaving the door open to fully dry. As the glass can break easily, ensure it is kept out of reach from children.

### 5. Replacing the Lamp

If the LED lamp is damaged, it must be replaced by the manufacturer or its service agent.

## Troubleshooting

| Trouble   | Cause and Remedy   |
|---|--|
| <b>No Refrigeration</b><br>Describes a refrigerator that completely fails to cool or maintain the desired temperature inside.       | <ul style="list-style-type: none"><li>▪ Check if the plug is properly inserted into the socket.</li><li>▪ Verify if the fuse is intact.</li><li>▪ Ensure there is power supply.</li></ul>  |
| <b>Unsatisfactory Refrigeration</b><br>Describes a refrigerator that is working but not cooling to the expected or set temperature. | <ul style="list-style-type: none"><li>▪ Check if the refrigerator is placed under direct sunlight or near any heat source.</li><li>▪ Ensure good ventilation in the surrounding area.</li><li>▪ Verify if the door is properly closed or has been left open for a long period.</li><li>▪ Inspect the door seal strip for any deformity or damage.</li><li>▪ Check if the refrigerator is overloaded or congested with food.</li><li>▪ Ensure food items do not block the air suction or outlet.</li><li>▪ Adjust the temperature controller as needed.</li></ul> |
| <b>Excessive Noise</b>  | <ul style="list-style-type: none"><li>▪ Check if the refrigerator is level.</li><li>▪ Verify if the refrigerator is in contact with a wall or another object.</li><li>▪ Check for any loose parts in the refrigerator.</li></ul>   |

## Note

Certain phenomena are normal and should not be considered as faults with your refrigerator:

- A murmuring or gurgling sound may be heard when the refrigerator is running. This is normal as it's simply the coolant circulating within the system.
- In humid weather, condensation may form on the exterior of the refrigerator. This is also normal and not a cause for concern. It occurs due to high humidity levels. Simply wipe it off with a cloth.

# Principle of Refrigeration System and Electric Circuit Diagram

The principle of the compression refrigeration system revolves around four main steps: "compression," "condensation," "throttling," and "vaporization."

The process operates as follows:

- **Compression:** The compressor takes in the coolant, which has absorbed heat in the evaporator, turning it into a high-pressure, high-temperature gas.
- **Condensation:** In the condenser, the coolant dissipates heat into the air. As a result, the coolant re-liquefies.
- **Throttling:** This phase is executed by the capillary, which throttles the re-liquefied coolant into the evaporator at a low pressure.
- **Vaporization:** Upon entering the evaporator, the liquefied coolant quickly boils and vaporizes into a gas due to the sudden drop in pressure. In this phase, it absorbs heat from inside the refrigerator.

Finally, the compressor again takes in the low-pressure, low-temperature gaseous coolant. The process repeats itself in a cycle, enabling the refrigerator to maintain its cool temperature.

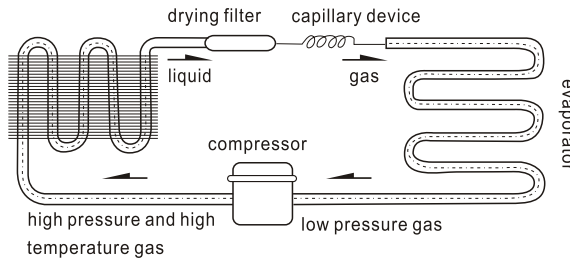

## Circuit Diagram

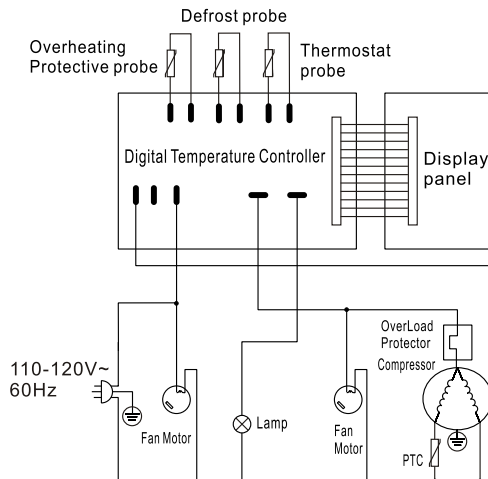

## Major Parameters

|                                    |                        |
|------------------------------------|------------------------|
| Model                              | <b>CDUR-3C</b>         |
| Coolant and Injection Quantity (g) | R134a(100) / R290(47)  |
| Type of Climate                    | 4                      |
| Refrigeration Temperature (°F)     | 32° - 50°              |
| Electric Shock Protection Class    | I                      |
| Storage Volume (Cu.Ft)             | 3.5                    |
| Overall Dimension (IN) (LxWxH)     | 18.9" x 18.9" x 40.55" |
| Net Weight (LB)                    | 110.2                  |
| Rated Voltage (V)                  | 110-120~               |
| Rated Current (A)                  | 2.6/1.95               |
| Rated Frequency (Hz)               | 60                     |
| Rated Input Power (W)              | 230/222                |
| Lamp Power                         | 6 (LED)                |

## Note

- If there have been any changes, the final electric circuit diagram and parameters are those stated on the product nameplate.
- The design may be improved without prior notice.



### WARNING

The refrigerator uses R290, a flammable refrigerant. Please take precautions against fire.

## Disposal Instructions



The crossed-out wheeled dustbin symbol indicates that electrical appliances should not be disposed of as unsorted municipal waste. Instead, utilize separate collection facilities.

For information regarding the available collection systems, contact your local government. If electrical appliances are improperly disposed of in landfills or dumps, hazardous substances can leak into the groundwater and enter the food chain, posing risks to health and well-being.

When replacing old appliances with new ones, check with your retailer about any haul-away or recycling programs they may offer for your old appliance. Remember to also check local regulations and available recycling programs in your area to ensure proper disposal.



# WARRANTY

## LIMITED WARRANTY

---

LIMITED WARRANTY KOOLMORE SUPPLY, INC. warrants to the original consumer or purchaser this KOOLMORE product is free from defects in material or workmanship for a period of One (1) year from the date of purchase. If any such defect is discovered within the warranty period, KOOLMORE SUPPLY, INC., at its discretion, will repair or replace the product at no cost or pay for replacement parts and repair labor to correct defects in materials or workmanship that existed when this major appliance was purchased or that are the result of normal usage when this major appliance is installed, operated and maintained according to instructions attached to or furnished with the product, At its sole discretion. Koolmore Supply Inc may determine to replace the product. In the event of product replacement, your appliance will be warranted for the remaining term of the original unit's warranty period.

This limited warranty is good only to the original purchaser of the product and effective only when used in the United States.

This limited warranty is effective from the date of original consumer purchase. Proof of original purchase date is required to obtain service under this limited warranty.

YOU'RE SOLE AND EXCLUSIVE REMEDY UNDER THIS LIMITED WARRANTY SHALL BE PRODUCT REPAIR AS PROVIDED HEREIN.

Service must be provided by a Koolmore designated service company.

For warranty or repair service: Email us at [support@koolmore.com](mailto:support@koolmore.com) include your name, address, phone number, warranty repair request, and a copy of your proof of purchase receipt.

You can also visit us at [koolmore.com](http://koolmore.com) and use the contact us page.

KOOLMORE customer service will contact you and arrange prompt service for your appliance.

Thank you for choosing KOOLMORE.

## THIS LIMITED WARRANTY DOES NOT APPLY TO

---

- 1.Failure of product to perform during power failures and interruptions or inadequate electrical service
- 2.Damage caused by transportation or handling.
- 3.Damage caused to the product by accident, vermin, lightning winds, fire, floods, or acts of God.
- 4.Damage resulting from accident, alteration, misuse, abuse, or improper installation, repair, or maintenance. Improper use includes using an external device that alters or converts the voltage or frequency of electricity
- 5.Any unauthorized product modification, repair by unauthorized repair center, or use of non-approved replacement parts.
- 6.Abnormal cleaning and maintenance as described in the user's manual.
- 7.Use of accessories or components that are not compatible with this product.

The cost of repair or replacement under these excluded circumstances shall be borne by the consumer.

