

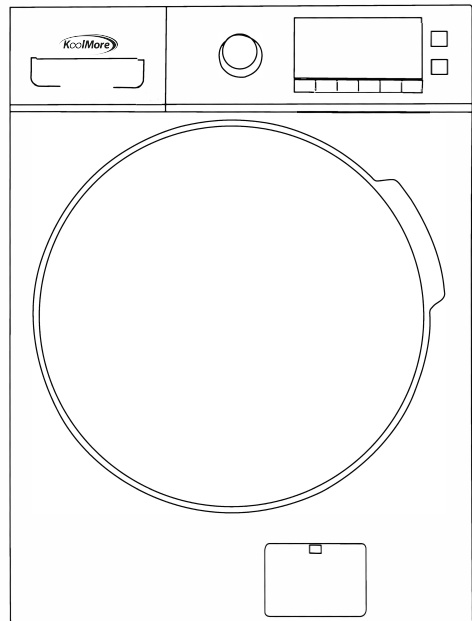

**Front Loader
Washing Machine**
FLW-5CWH

Power supply: 120V
Circuit: 15-amp branch

**USER MANUAL &
INSTALLATION
INSTRUCTIONS**



Warning:
Before using this product,
please read this manual carefully
and keep it for future reference.
The design and specifications
are subject to change without
prior notice for product
improvement. Consult with your
dealer or manufacturer for
details.

**For any service-related
Issues, please contact us:**

Phone Number: 718-576-6342

Email address: support@koolmore.com

Dear user

THANK YOU and CONGRATULATIONS on your purchase of this high-quality Koolmore product. Your Koolmore washer is designed for reliable, trouble-free performance. Please take a moment to register your new washer.

Register your new washer at **www.koolmore.com** under the **Product Registration** tab.

For future reference, record your product model and serial numbers located on the inside frame of the washer.

Model Number _____

Serial Number _____

WASHER SAFETY	3
Proper Installation	5
When Not in Use	5
OPERATION REQUIREMENTS	6
Location of Your Washer	6
Electrical Requirements	6
Water Supply Requirements	7
Drain Requirements	7
INSTALLATION INSTRUCTIONS	8
Before You Begin	8
Tools Required	9
Parts Required (Obtain Locally)	9
Parts Supplied.....	9
Rough-In Dimensions	9
Unpacking the Washer	10
Installing the Washer	11
WASHER USE	13
Control Panel	13
Features	20
Loading and Using the Washer	23

WASHER CARE24
 Cleaning24
 Moving, Storage and Long Vacations28
BEFORE YOU CALL FOR SERVICE... ..29
 Error Codes36
WARRANTY37
PRODUCT REGISTRATION39

WASHER SAFETY

YOUR SAFETY AND THE SAFETY OF OTHERS ARE VERY IMPORTANT

To prevent injury to the user or other people and property damage, the instructions shown here must be followed. Incorrect operation due to ignoring of instructions may cause harm or damage, including death.

The level of risk is shown by the following indications.



This symbol indicates the possibility of death or serious injury.



This symbol indicates the possibility of injury or damage to property.



This symbol indicates the possibility of dangerous voltage constituting a risk of electrical shock is present that could result in death or serious injury.

IMPORTANT SAFETY INSTRUCTIONS

WARNING

To reduce the risk of death, fire, explosion, electric shock, or injury to persons when using your vfd appliance, follow basic precautions, including the following:

- Read the instruction manual before using the appliance.
- DO NOT wash or dry articles that have been previously cleaned in, washed in, soaked in or spotted with gasoline, dry-cleaning solvents, or other flammable or explosive substances, as they give off vapors that could ignite or explode.
- DO NOT add gasoline, dry-cleaning solvents, or other flammable or explosive substances to the wash water. These substances give off vapors that could ignite or explode.
- Under certain conditions, hydrogen gas may be produced in a hot-water system that has not been used for 2 weeks or more. **HYDROGEN GAS IS EXPLOSIVE.** If the hot water system has not been used for such a period, before using a washing machine, turn on all hot-water faucets and let the water flow from each for several minutes. This will release any accumulated hydrogen gas. As the gas is flammable, DO NOT smoke or use an open flame during this time.
- DO NOT allow children to play on or in this appliance. Close supervision of children is necessary when this appliance is used near children. Before the washer is removed from service or discarded, remove the door or lid. Failure to follow these instructions may result in death or injury to persons.
- DO NOT reach into the appliance if the drum or other components are moving to prevent accidental entanglement.
- DO NOT install or store this appliance where it will be exposed to the weather.
- DO NOT tamper with controls, repair or replace any part of this appliance or attempt any servicing unless specifically recommended in the user maintenance instructions or in published user repair instructions that you understand and have the skills to carry out.
- Keep the area around your appliance clean and dry to reduce the possibility of slipping.
- DO NOT operate this appliance if it is damaged, malfunctioning, partially disassembled, or has missing or broken parts including a damaged cord or plug.
- Unplug the appliance or turn off the circuit breaker before servicing. Pressing the Power button DOES NOT disconnect power.
- See “Electrical Requirements” located in the Installation Instructions for grounding instructions. This appliance is not intended for use by persons (including children) with reduced physical, sensory or mental capabilities, or lack of experience and knowledge, unless they have been given supervision or instruction concerning use of the appliance by a person responsible for their safety. Children should be supervised to ensure that they do not play with appliance.

- If the supply cord is damaged, it must be replaced by the manufacture, its service agent or similarly qualified persons in order to avoid a hazard.
- The new hose-sets bought from the retailer where the product was purchased are to be used and that old hose-sets should not be reused.
- This appliance is for indoor use only.

SAVE THESE INSTRUCTIONS

PROPER INSTALLATION

- This washer must be properly installed and located in accordance with the Installation Instructions before it is used. Ensure the cold water hose is connected to the “C” valve.
- Install or store where it will not be exposed to temperatures below freezing or exposed to the weather, which could cause permanent damage and invalidate the warranty. Properly ground washer to conform with all governing codes and ordinances. Follow details in installation instructions.

WARNING

Electrical Shock Hazard



- Plug into a grounded 3 prong outlet.
- Do not remove the ground prong.
- Do not use an adapter.
- Do not use an extension cord.
- Failure to do so can result in death, fire or electrical shock.

WHEN NOT IN USE

Turn off water faucets to minimize leakage if a break or rupture should occur. Check the condition of the fill hoses; We recommend changing the hoses every 5 years.

State of California Proposition 65 Warnings:

 **WARNING: Cancer and Reproductive Harm**
-www.P65Warnings.ca.gov.

SAVE THESE INSTRUCTIONS

THIS APPLIANCE IS FOR HOUSEHOLD USE ONLY

OPERATION REQUIREMENTS

LOCATION OF YOUR WASHER

DO NOT INSTALL THE WASHER:

1. In an area exposed to dripping water or outside weather conditions. The ambient temperature should never be below 60°F (15.6°C) for proper washer operation.
2. In an area where it will come in contact with curtains or drapes.
3. On carpet. The floor **MUST** be a hard surface with a maximum slope of 1/2" per foot (1.27 cm per 30 cm). To make sure the washer does not vibrate or move, you may have to reinforce the floor.

NOTE: If floor is in poor condition, use 3/4" impregnated plywood sheet solidly attached to the existing floor covering.

IMPORTANT: MINIMUM INSTALLATION CLEARANCES

- When installed in alcove: Top and Sides = 0" (0 cm), Back = 3" (7.6 cm)
- When installed in closet: Top and Sides = 0" (0 cm), Front = 2" (5 cm), Back = 3" (7.6 cm)
- Closet door ventilation openings required: 2 louvers each 60 square in. (387 cm), located 3" (7.6 cm) from top and bottom of door

ELECTRICAL REQUIREMENTS

Read these instructions completely and carefully.

WARNING

TO REDUCE THE RISK OF FIRE, ELECTRICAL SHOCK AND PERSONAL INJURY:

- **DO NOT USE AN EXTENSION CORD OR AN ADAPTER PLUG WITH THIS APPLIANCE. Washer must be electrically grounded in accordance with local codes and ordinances.**

CIRCUIT - Individual, properly polarized and grounded 16-amp branch circuit fused with 16-amp time - delay fuse or circuit breaker.

POWER SUPPLY - 2-wire with ground, 12V, single-phase, 60Hz, alternating current.

OUTLET RECEPTACLE - Properly grounded receptacle located so the power supply cord is accessible when the washer is in an installed position.

GROUNDING REQUIREMENTS

Improper connection of the equipment grounding conductor can result in a risk of electrical shock. Check with a licensed electrician if you are in doubt as to whether the appliance is properly grounded.

1. The washer **MUST** be grounded. In the event of malfunction or breakdown, grounding will reduce the risk of electrical shock by providing a path of least resistance for electrical current.
2. Since your washer is equipped with a power supply cord having an equipment-grounding conductor and a grounding plug, the plug **MUST** be plugged into an appropriate, copper-wired receptacle that is properly installed and grounded in accordance with all local codes. If in doubt, call a licensed electrician. **DO NOT** cut off or alter the grounding prong on the power supply cord. In situations where a two-slot receptacle is present, it is the owner's responsibility to have a licensed electrician replace it with a properly grounded grounding-type receptacle.

WATER SUPPLY REQUIREMENTS

Hot and cold water faucet **MUST** be installed within 42" (107 cm) of your washer's water inlet. The faucet **MUST** be 3/4" (1.9 cm) garden hose-type so inlet hoses can be connected. Water pressure **MUST** be between 10 and 120 psi. Your water department can advise you of your water pressure.

DRAIN REQUIREMENTS

1. Drain capable of eliminating 64.3 L per minute.
2. A standpipe diameter of 1 1/4" (3.18 cm) minimum.
3. The standpipe height above the floor should be:

Minimum height: 24" (61 cm)

Maximum height: 47.24" (120 cm)

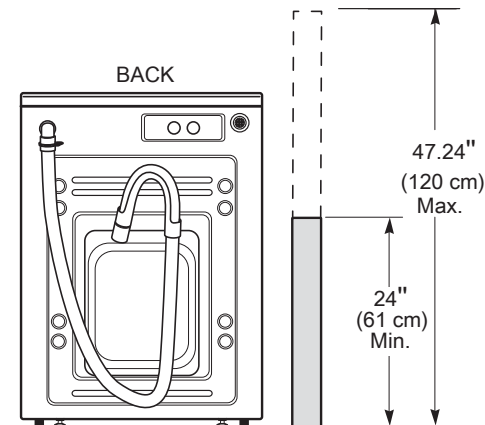

INSTALLATION INSTRUCTIONS

BEFORE YOU BEGIN

Read these instructions completely and carefully.

- **IMPORTANT** - Save these instructions for local inspector's use.
- **IMPORTANT** - Observe all governing codes and ordinances.
- **NOTE TO INSTALLER** - Be sure to leave these instructions with the Consumer.
- **NOTE TO CONSUMER** - Keep these instructions for future reference.
- **Skill level** - Installation of this appliance requires basic mechanical and electrical skills.
- **Completion time** - 1-3 hours.
- **Proper installation is the responsibility of the installer.**
- **Product failure due to improper installation is not covered under the Warranty.**

FOR YOUR SAFETY:

WARNING

- This appliance must be properly grounded and installed as described in these Installation Instructions.
- Do not install or store the appliance in an area where it will be exposed to water/weather. See the Location of Your Washer section.
- **NOTE:** This appliance must be properly grounded, and electrical service to the washer.
- Certain internal parts are intentionally not grounded and may present a risk of electric shock only during servicing. Service Personnel - Do not contact the following parts while the appliance is energized: Electrical Valve, Drain Pump, Heater and Motor.

TOOLS REQUIRED

- Adjustable wrench or 1/2" socket with ratchet
- Adjustable wrench or 9/16" open-end wrench
- Channel-lock adjustable pliers
- Carpenter's level

PARTS REQUIRED (OBTAIN LOCALLY)

Water Hose (2)



PARTS SUPPLIED

Cable Tie



Drain Hose Guide

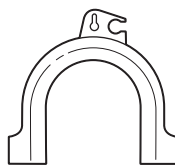

Inlet Hose Screen Washers(2)



ROUGH-IN DIMENSIONS

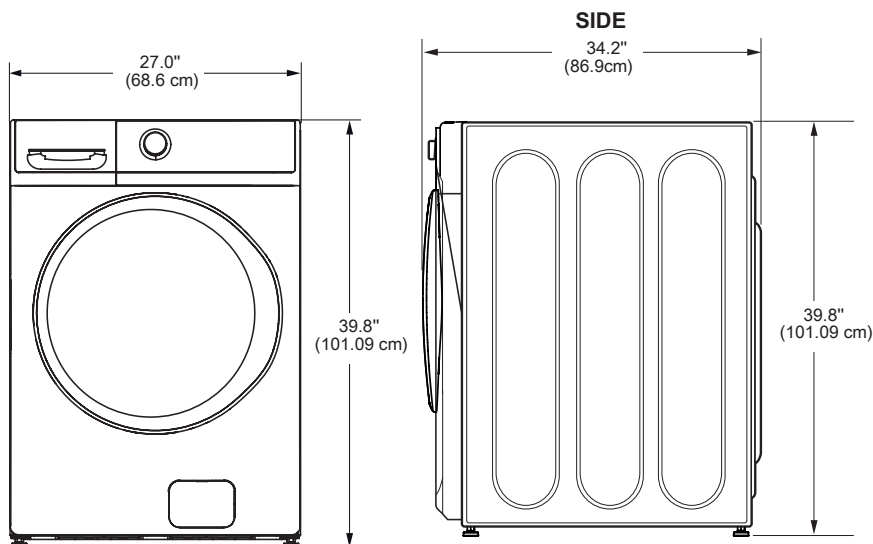

*NOTE: With pedestal, 52.6"
Stacked, 84"

UNPACKING THE WASHER

⚠ WARNING:

- Recycle or destroy the carton and plastic bags after the washer is unpacked. Make materials inaccessible to children. Children might use them for play. Cartons covered with rugs, bedspreads or plastic sheets can become airtight chambers causing suffocation.

1. Cut and remove the top and bottom packaging straps.
2. While it is in the carton, carefully lay the washer on its side. **DO NOT** lay the washer on its front or back.
3. Turn down the bottom flaps-remove all base packaging, including the cardboard, styrofoam base and styrofoam tub support (inserted in center of base).

NOTE: If you are installing a pedestal, proceed to the installation instructions that come with the pedestal.

4. Carefully return the washer to an upright position and remove the carton.
5. Carefully move the washer to within 4 feet (122 cm) of the final location.
6. Remove the following from the back side of the washer:
 - 4 bolts
 - 4 plastic spacers (including rubber grommets)
 - 4 power cord retainers

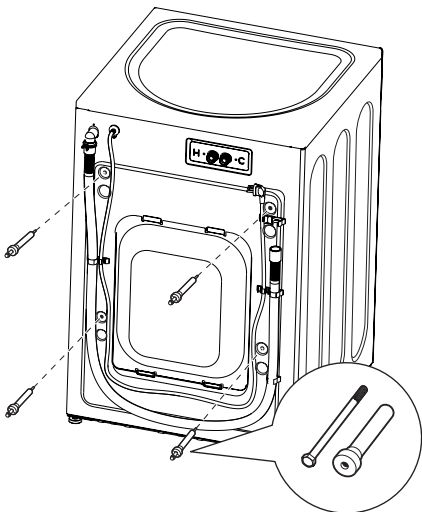

IMPORTANT: Failure to remove the shipping bolts* can cause the washer to become severely unbalanced.

Save all bolts for future use.

* Any damages from failure to remove the shipping bolts are not covered by the warranty.

NOTE: If you must transport the washer at a later date, you must reinstall the shipping support hardware to prevent shipping damage. Keep the hardware in the plastic bag provided.

INSTALLING THE WASHER

1. Run some water from the cold faucet to flush the water lines and remove particles that might clog up the inlet hose.
2. Ensure there is a rubber washer in the hoses. Reinstall the rubber washer into the hose fitting if it has fallen out during shipment. Carefully connect the inlet hose marked **HOT** to the rear “**H**” inlet of the water valve. Tighten by hand; then tighten another 2/3 turn with pliers. And **COLD** to the rear “**C**” inlet of the water valve. Tighten by hand; then tighten another 2/3 turn with pliers.

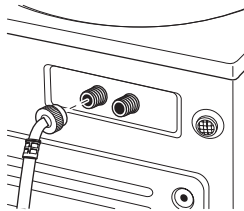

Do not crossthread or over-tighten these connections.

3. Install the screen washers by inserting them into the free ends of the inlet hoses with protruded side facing the faucet.
4. Connect the inlet hose ends to the HOT and COLD water faucets tightly by hand, then tighten another 2/3 turn with pliers. Turn the water on and check for leaks.

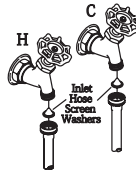

5. Carefully move the washer to its final location. Gently lock the washer into position ensuring inlet hoses do not become kinked. It is important not to damage the rubber leveling legs when moving your washer to its final location. Damaged legs can increase washer vibration. It may be helpful to spray window cleaner on the floor to help move your washer into its final position.

NOTE: To reduce vibration, ensure that all four rubber leveling legs are firmly touching the floor. Push and pull on the back right and then back left of your washer.

NOTE: Do not use the dispenser drawer or door to lift the washer.

NOTE: If you are installing into a drain pan, you can use a 24-inch long 2x4 to lever the washer into place.

6. With the washer in its final position, place a level on top of the washer (if the washer is installed under a counter, the washer should not be able to rock). Adjust the front leveling legs up or down to ensure the washer is resting solid. Turn the locknuts on each leg up towards the base of the washer and snug with a wrench.

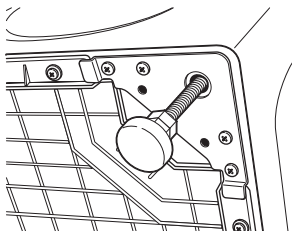

NOTE: Keep the leg extension at a minimum to prevent excessive vibration. The farther out the legs are extended, the more the washer will vibrate.

If the floor is not level or is damaged, you may have to extend the rear leveling legs.

7. Attach the U-shaped hose guide to the end of the drain hose. Place the hose in a laundry tub or standpipe and secure it with the cable tie provided in the enclosure package.

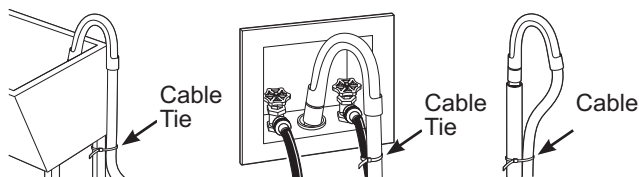

NOTE: Placing the drain hose too far down the drain pipe can cause a siphoning action. No more than 7 inch (17.78 cm) of hose should be in the drain pipe. There must be an air gap around the drain hose. A snug fit can also cause a siphoning action.

8. Plug the power cord into a grounded outlet.
NOTE: Check to be sure the power is off at the circuit breaker/fuse box before plugging the power cord into an outlet.
9. Turn on the power at the circuit breaker/fuse box.
10. Read the rest of this Owner's Manual. It contains valuable and helpful information that will save you time and money.
11. Before starting the washer, check to make sure:
 - Main power is turned on.
 - The washer is plugged in.

- The water faucets are turned on.
- The unit is level and all four leveling legs are firmly in the floor.
- The shipping support hardware is removed and saved.
- The drain hose is properly tied up.

12. Run the washer through a complete cycle.

13. If your washer does not operate, please review the Before You Call For Service section before calling for service.

14. Place these instructions in a location near the washer for future reference.

WASHER USE

CONTROL PANEL

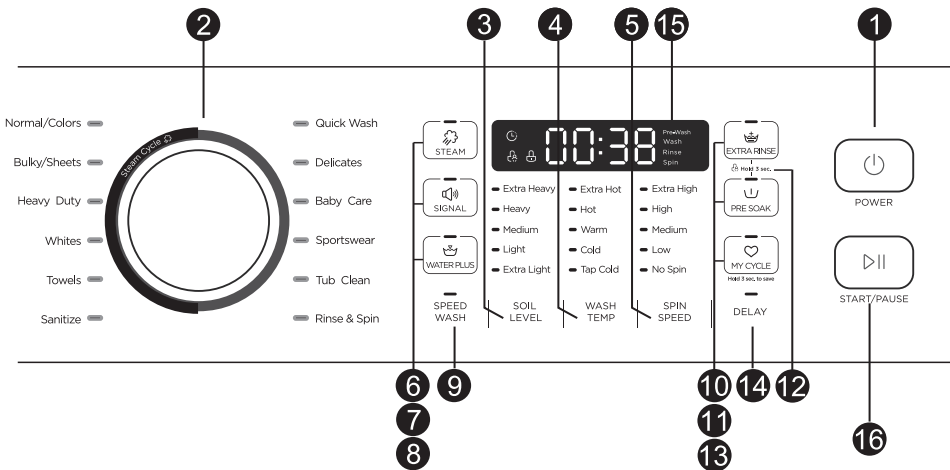

QUICK START

- 1 Press the Power button. 

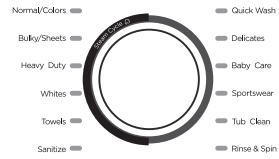

If the screen is dark, a press of the Power button will “wake up” the display.

- 2 Select a wash cycle. (Defaults are set for each cycle. These default settings can be changed. See Control setting for more information).



- 3 Press the START/PAUSE button. 

CONTROL SETTING

- 1 **Power**
Press  to “wake up” the display. If the display is active, press  to put the washer into standby mode.
NOTE: Pressing Power does not disconnect the appliance from the power supply.

2 Wash Cycles

The wash cycles are optimized for specific types of wash loads. The chart below will help you match the setting with the loads.

Normal/ Colors*	For heavily to lightly soiled colorfast cottons, household linens, work and play clothes. NOTE: This is the most common cycle.
Bulky/ Sheets*	For large items such as comforters, blankets, small rugs and similar bulky items.
Heavy Duty*	Washing the large and heavy clothing, such as overcoats or towels.
Whites*	For heavily to lightly soiled white laundry, work and play clothes
Towels*	For items such as towels, sheets, pillowcases and dish rags.
Sanitize*	For increased water temperature which will sanitize and kill more than 99.9% of many common bacteria found in home laundry. For best results, select the extra heavy soil setting when using the Sanitize cycle.
Quick Wash	For lightly soiled items needed in a hurry. Cycle time is approximately 40 minutes, depending on selected options.
Delicates	For delicate, washable textiles, e.g. made of silk, satin, synthetic fibers or blended fabrics.
Baby Care	Washing the baby's clothes, it can make the baby's wear cleaner and make the rinse performance better to protect the baby skin.
Sportswear	Washing the activewear.
Tub Clean	Use for cleaning the basket of residue and odor. Recommended use of at least once per month. NOTE: Never load laundry white using Tub Clean. The laundry may become damaged See the Care and Cleaning section.
Rinse & Spin	To quickly rinse and spin out any items at any time.

3 SOIL LEVEL

Change the **Soil** level to increase or decrease the wash time to remove different amounts of soil.

To change the **Soil** level, press the **Soil** level button until you have reached the desired setting. You can choose between Extra Light, Light, Medium, Heavy or Extra Heavy soil levels.

4 WASH TEMP

Adjust to select the proper main water temperature for the wash cycle. The PreWash rinse water is always cold to help reduce energy usage and reduce setting of stains and wrinkles.

To change the wash temperature, press the wash Temp button until you have reached the desired setting. You can choose between Tap Cold, Cold, Warm, Hot or Extra Hot.

Follow the fabric manufacturer's care label when selecting the wash temperature.

By design, to protect fabrics, not all wash temperatures are available for certain wash cycles.

5 SPIN SPEED

Changing the **Spin** speed changes the final **spin** speed of the cycles. Always follow the garment manufacturer's care label when changing the Spin speed.

To change the **Spin** speed, press the **Spin** speed button until you have reached the desired setting. You can choose between No Spin, Low, Medium, High or Extra High. Higher spin speeds are not available on certain cycles, such as Delicates. Higher spin speeds remove more water from the clothes and will help reduce dry time, but may also increase the possibility of setting wrinkles on some fabrics.

6 STEAM

Steam adds steam into the washer to assist with loosening stains on the Normal/Colors, Bulky/ Sheets, Heavy Duty, Whites, Towels or Sanitize cycle.

To use:

1. Turn power ON and select a wash cycle.
2. Select the Add Steam button to activate steam.
3. Press the **▶||** button.

7 SIGNAL

Use the Signal pad to turn the Signal on or off all knob turns and button presses.

Press the pad until you reach the desired volume. Turn Signal on, signal beeps means it is an acceptable option, and a double beeps means not an acceptable option.

8 WATER PLUS

Increases the water level of the main wash.

To use:

Option is available on Normal/Colors, Bulky/ Sheets, Heavy Duty, Whites, Towels, Sanitize, Delicates, Baby Care, Sportswear

1. Turn power ON and select a wash cycle.
2. Select the Add Water Plus button to activate water plus.
3. Press the **▶||** button.

9 SPEED WASH

This option reduces the overall washer cycle time by optimizing the wash, rinse and spin actions and/or gently raising the wash temperature to get clothes cleaned faster. Option is available on Normal/ Colors, Bulky/Sheets, Heavy Duty, Whites, Towels, Baby Care or Sportswear cycles. Total wash time will vary based on cycle chosen and options selected.

To use:

1. Turn power on and select a wash cycle which has Speed Wash as an option.
2. Make any adjustments to Soil, Temp and Spin as desired.
3. Press the Speed Wash button to reduce the overall wash time.
4. Press the **▶||** button.

10 EXTRA RINSE

This option allows for an extra rinse during a cycle to remove excess dirt and detergent from soiled loads.

11 PRE SOAK

For soaking your garments prior to the wash cycle. This option begins with a brief tumble and then proceeds to soak the clothes with water and detergent for a specified period of time. Once complete, the cycle will begin automatically. **Pre Soak** must be selected prior to pressing **▶||** button.

The **Pre Soak** time will add an additional 10-20 minutes to the overall wash time. High-efficiency detergent from the main wash compartment in the dispenser is used for the **Pre Soak** period and main wash cycle.

12 EXTRA RINSE and PRE SOAK

 Hold 3 sec.

You can lock the controls to prevent any selections from being made. Or you can lock or unlock the controls after you have started a cycle.

Children cannot accidentally start the washer by touching buttons with this option selected.

To lock the washer, press and hold the **Extra Rinse and Pre Soak buttons** for 3 seconds.

To unlock the washer controls, press and hold **Extra Rinse and Pre Soak buttons** for 3 seconds.

NOTE: The **Power** button can still be used when the machine is locked.

13 MY CYCLE

 Hold for 3 sec. to save

To save a favorite cycle, set the desired setting for wash cycle, soil level, spin speed and wash temp settings and hold down the My Cycle button for 3 seconds. A beep will sound to indicate the cycle has been saved.

To use your custom cycle, press the **My Cycle** button before washing a load.

To change the saved cycle, set the desired setting and hold down the **My Cycle** button for 3 seconds.

NOTE: When using **My Cycle**, wash options cannot be modified after the cycle has been started.

NOTE: If you change wash options with **My Cycle** before starting the cycle, the **My Cycle** light will turn off and you will be returned to the base cycle.

14 DELAY

You can delay the start of a wash cycle for up to 24 hours. Press the Delay Wash button to choose the amount of time you want to delay the start of the wash cycle. Once the desired time is reached, press the ▶|| button. The machine will count down and start automatically at the correct time.

NOTE: If you forget to close the door, a double beep will sound when pressing pause/add garment button.

NOTE: If you open the door when the delay is counting down, the machine will enter the pause state. You must close the door and press ▶|| button again in order to restart the countdown.

15 Display

Displays the approximate time remaining until the end of the cycle.

NOTE: The cycle time is affected by the water pressure in your home and the balance of the load in the washer. You may see the time remaining on the display increase to accommodate a slower spin speed to handle unbalanced loads.

Cycle status is also displayed and certain features such as Delay Wash or Steam are shown indicating they have been selected.

A Display

Wash Time	Delay Time
1:25	2H
End	Error
End	E 30

B Remain-Delay

C Child Lock

D Door Lock



16



START/PAUSE

Press to start a wash cycle. If the washer is running, pressing it once will pause the washer. Press again to restart the wash cycle.

If you want add a garment, please press the ▶|| button.

The washer will unlock the door. Press again to restart the cycle.

NOTE: In some cycles the washer will drain first, then unlock the door when it is paused.

NOTE: The washer performs automatic system checks after pressing the ▶|| button.

You may hear the door lock and unlock before water flows, this is normal.

FEATURES

THE DISPENSER DRAWER

Slowly open the dispenser drawer by pulling it out until it stops. After adding laundry products, slowly close the dispenser drawer. Closing the drawer too quickly could result in early dispensing of the bleach, fabric softener or detergent.

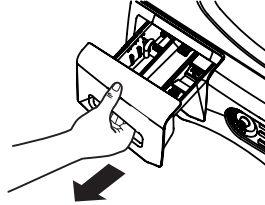

You may see water in the dispenser drawer at the end of the cycle. This is a result of the flushing/siphoning action and is part of the normal operation of the washer.

NOTE: Liquid detergent will drain into the washer drum as it is added.

- Detergent usage may need to be adjusted for water temperature, water hardness, size and soil level of the load. Avoid using too much detergent in your washer as it can lead to over sudsing and detergent residue being left on the clothes.

The Detergent Compartment

- High-efficient detergent is required for this washer. Use the detergent manufacturer's recommended amount.
- Add measured detergent to the front left detergent compartment of the dispenser drawer.

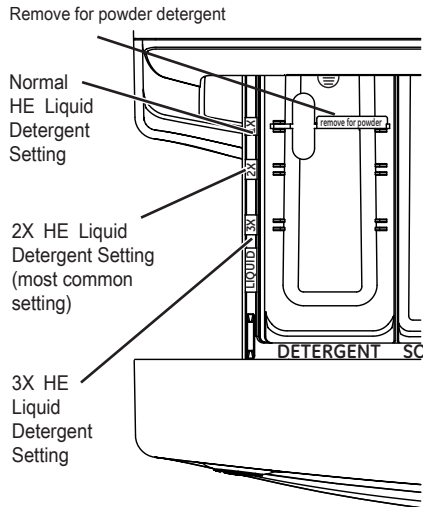

- Detergent is flushed from the dispenser at the beginning of the wash cycle. Either powdered or liquid detergent can be used.
- Powder Detergent-Remove the Detergent selection insert and place it in a safe location outside of the washer. Follow the detergent manufacturer's instructions when measuring the amount of powder to use.
- Detergent usage may need to be adjusted for water temperature, water hardness, size and soil level of the load. Avoid using too much detergent in your washer as it can lead to oversudsing and detergent residue being left on the clothes.
- Using more detergent than the recommended quantity can cause residue buildup on your washer.
- Liquid Detergent - Locate the concentration of your detergent on the bottle. Place the Detergent selection insert in the corresponding location depending on the concentration.

The Liquid Bleach Compartment

IMPORTANT: Be sure to identify the correct compartment for bleach before using.

If desired, measure out the recommended amount of liquid bleach, not to exceed 1/3 cup (80 ml), and pour into the right compartment labeled "LIQUID BLEACH".

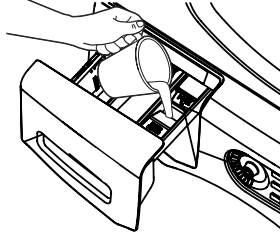

Do not exceed the maximum fill line. Overfilling can cause early dispensing of the bleach which could result in damaged clothes

NOTE: Do not use powdered bleach in the dispenser.

The Fabric Softener Compartment

IMPORTANT: Be sure to identify the correct compartment for fabric softener before using.

If desired, pour the recommended amount of liquid fabric softener into the compartment labeled "FABRIC SOFTENER".

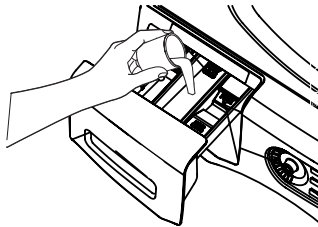

Use only liquid fabric softener in the dispenser.

Dilute with water to the maximum fill line.

Do not exceed the maximum fill line. Overfilling can cause early dispensing of the fabric softener which could stain clothes.

NOTE: Do not pour fabric softener directly on the wash load.

LOADING AND USING THE WASHER

Always follow fabric manufacturer's care label when laundering.

SORTING WASH LOADS

Sort laundry into loads that can be washed together.

COLORS	SOIL	FABRIC	LINT
Whites	Heavy	Delicates	Lint Producers
Lights	Normal	Easy Care	Lint Collectors
Darks	Light	Sturdy Cottons	

- Combine large and small items in a load. Load large items first. Large items should not be more than half the total wash load.
- Washing single items is not recommended. This may cause an out-of-balance load. Add one or two similar items.
- Pillows and comforters should not be mixed with other items. This may cause an out-of-balance load.

WARNING



Fire Hazard

- Never place items in the washer that are dampened with gasoline or other flammable liquids.
- No washer can completely remove oil.
- Do not dry anything that has ever had any type of oil on it (including cooking oils).
- Doing so can result in death, explosion, or fire.

PREPARING CLOTHES

To avoid snags during washing:

Follow these steps to maximize garment care.

- Close garment zippers, snaps, buttons and hooks.
- Mend seams, hems, tears.
- Empty all items from pockets.
- Remove nonwashable garment accessories such as ornaments and nonwashable trim materials.
- To avoid tangling, tie strings, draw ties and belt-like materials.
- Brush away surface dirt and lint.
- Promptly wash wet or stained garments to maximize results.
- Use nylon mesh garment bags to wash small items.
- Wash multiple garments at one time for best results.

LOADING THE WASHER

Wash drum may be fully loaded with loosely added items. Do not wash fabrics containing flammable materials (waxes, cleaning fluids, etc.).

To add items after washer has started, press **▶||** and wait until the door is unlocked. The washer may take up to 30 seconds to unlock the door after pressing **▶||** depending on the machine conditions.

Do not try to force open the door when it is locked.

After the door unlocks, open gently. Add items, close the door and press **▶||** to restart.

WASHER CARE

CLEANING

EXTERIOR

Immediately wipe off any spills. Wipe with damp cloth. Do not hit surface with sharp objects.

INTERIOR

To clean the interior of the washer, select the Tub Clean feature on the control panel. This Tub Clean cycle should be performed, at a minimum, once per month. This cycle will use more water, in addition to bleach, to control the rate at which soils and detergents may accumulate in your washer.

NOTE: Read the instructions below completely before starting the Tub Clean cycle.

1. Remove any garments or objects from the washer and ensure the washer basket is empty.
2. Open the washer door and pour one cup or 250 ml of liquid bleach or other washing machine cleaner into the basket.

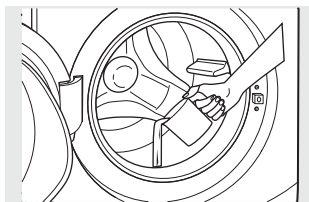

3. Close the door and select the Tub Clean cycle. Push the **▶||** button.
4. When the Tub Clean cycle is working, the display will show the estimated cycle time remaining. The cycle will complete in about 90 minutes. Do not interrupt the cycle.

5. After the cycle is complete, leave the door open slightly for better ventilation.

If for any reason the cycle needs to be interrupted, the door will not open immediately. Forcing open the door at this stage may cause water to flood. The door will open after the water is drained to a level where it would not flood the floor.

Tub Clean may be interrupted by pressing **||** button in between cycles. A power outage in the house might also interrupt the cycle. When the power supply is back, the Tub Clean cycle resumes where it had stopped. When interrupted, be sure to run a complete Tub Clean cycle before using the washer. If the Power pad is pressed during Tub Clean, the cycle will be lost.

IMPORTANT:

- Run Tub Clean with 1 Cup (250 ml) of bleach once a month.
- After the completion of a Tub Clean cycle, the interior of your washer may have a bleach smell.
- It is recommended to run a light color load after the Tub Clean cycle.

DISPENSER DRAWER AREA

Detergent and fabric softener may build up in the dispenser drawer. Residue should be removed once or twice a month.

Lock tab is visible only after drawer has been pulled open.

Remove the drawer by first pulling it out until it stops. Then reach back into the left rear corner of the drawer cavity and press down firmly on the lock tab, pulling out the drawer.

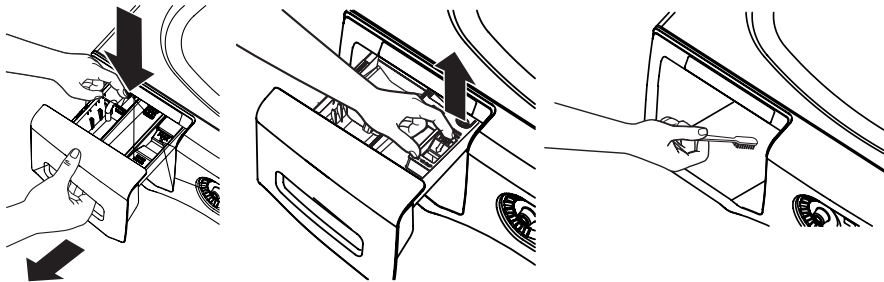

CLEANING THE PUMP FILTER

Due to the nature of the front-load washer, it is sometimes possible for small articles to pass to the pump. The washer has a filter to capture lost items so they are not dumped to the drain. To retrieve lost items, clean out the pump filter.

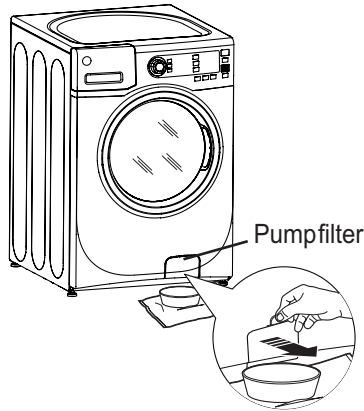

1. Using a coin or flat screwdriver in the notch on the door, open the access door.

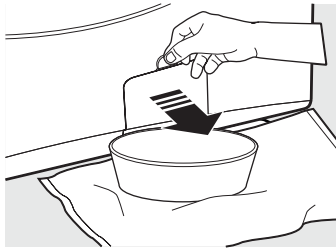

2. Place a shallow pan or dish under the pump access door and towels on the floor in front of the washer to protect the floor. It is normal to catch about a cup of water when the filter is removed.

3. Pull down the pour spout.

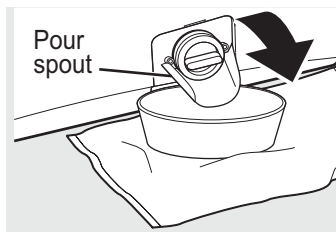

4. Turn the pump filter counterclockwise and remove the filter. Open slowly to allow the water to drain.

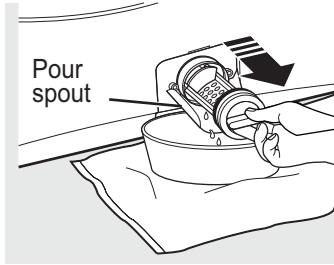

5. Clean the debris from the filter.
6. Replace the filter and turn clockwise. Tighten securely.
7. Flip up the pour spout.
8. Close the access door.

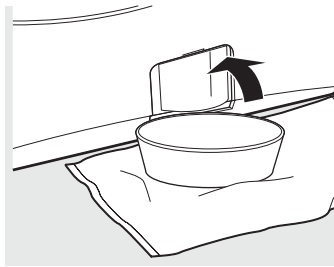

CLEANING THE DOOR GASKET

1. Open the washer door. Using both hands, press down the door gasket. Remove any foreign objects if found trapped inside the gasket. Make sure there is nothing blocking the holes behind the gasket.

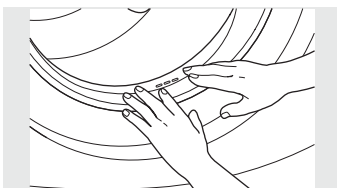

2. While holding down the door gasket, inspect the interior gasket by pulling it down with your fingers. Remove any foreign objects if found trapped inside this gasket. Make sure there is nothing blocking the holes behind the gasket.

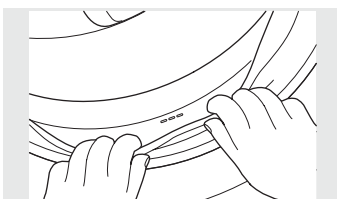

3. When you are finished cleaning the door gasket, remove your hands and the gasket will return to the operating position.

MOVING, STORAGE AND LONG VACATIONS

Ask the service technician to remove water from drain pump and hoses. Do not store the washer where it will be exposed to the weather. When moving the washer, the tub should be kept stationary by using the shipping bolts removed during installation. See Installation Instructions in this book.

Be sure the water supply is shut off at the faucets. Drain all water from the hoses if the weather will be below freezing.

Certain internal parts are intentionally not grounded and may present a risk of electric shock only during servicing. Service Personnel - Do not contact the following parts while the appliance is energized: Electrical Valve, Drain Pump, Heater and Motor.

BEFORE YOU CALL FOR SERVICE...

Troubleshooting Tips

Save time and money! Review the charts on the following pages first and you may not need to call for service.

Problem	Possible Cause	What To Do
Not draining Not spinning Not agitating	Load is out of balance	<ul style="list-style-type: none"> • Redistribute clothes and run drain & spin or rinse & spin. • Increase load size if washing small load containing heavy and light items.
	Pump clogged	<ul style="list-style-type: none"> • See page 26 on how to clean the Pump Filter.
	Drain hose is kinked or improperly connected	<ul style="list-style-type: none"> • Straighten drain hose and make sure washer is not sitting on it.
	Household drain may be clogged	<ul style="list-style-type: none"> • Check household plumbing. You may need to call a plumber.
	Drain hose siphoning; drain hose pushed too far down the drain	<ul style="list-style-type: none"> • Ensure there is an air gap between hose and drain.
Leaking water	Door gasket is damaged	<ul style="list-style-type: none"> • Check to see if gasket is seated and not torn. Objects left in pockets may cause damage to the washer (nails, screws, pens, pencils).
	Door gasket not damaged	<ul style="list-style-type: none"> • Water may drip from the door when the door is opened. This is a normal operation. • Carefully wipe off rubber door seal. Sometimes dirt or clothing is left in this seal and can cause a small leak.
	Check back left of washer for water	<ul style="list-style-type: none"> • If this area is wet, you have oversudsing condition. Use less detergent.

Problem	Possible Cause	What To Do
Leaking water (cont.)	<p>Fill hoses or drain hose is improperly connected</p> <p>Household drain may be clogged</p> <p>Dispenser clogged</p> <p>Incorrect use of detergent</p> <p>Dispenser box crack</p>	<ul style="list-style-type: none"> • Make sure hose connections are tight at washer and faucets and make sure end of drain hose is correctly inserted in and secured to drain facility. • Check household plumbing. You may need to call a plumber. • Powder soap may cause clogs inside the dispenser and cause water to leak out the front of the dispenser. Remove drawer and clean both drawer and inside of dispenser box. Please refer to Cleaning the Washer section. • Use HE and correct amount of detergent. • If new installation, check for crack on inside of dispenser box.
Clothes too wet	<p>Load is out of balance</p> <p>Pump clogged</p> <p>Overloading</p> <p>Drain hose is kinked or improperly connected</p>	<ul style="list-style-type: none"> • Redistributes clothes and run drain & spin or rinse & spin. • Increase load size if washing small load containing heavy and light items. • The machine will slow the spin speed down to 400 rpm if it has a hard time balancing the load. This speed is normal. • See page 26 on how to clean the Pump Filter. • The dry weight of the load should be less than 18 lbs. • Straighten drain hose and make sure washer is not sitting on it.

Problem	Possible Cause	What To Do
Clothes too wet (cont.)	Household drain may be clogged	<ul style="list-style-type: none"> • Check household plumbing. You may need to call a plumber.
	Drain hose siphoning; drain hose pushed too far down the drain	<ul style="list-style-type: none"> • Ensure there is an air gap between hose and drain.
Incomplete cycle or timer not advancing	Automatic load redistribution	<ul style="list-style-type: none"> • Timer adds 3 minutes to cycle for each rebalance. 11 or 15 rebalances may be done. This is normal operation. Do nothing; the machine will finish the wash cycle.
	Pump clogged	<ul style="list-style-type: none"> • See page 26 on how to clean the Pump Filter.
	Drain hose is kinked or improperly connected	<ul style="list-style-type: none"> • Straight drain hose and make sure washer is not sitting on it.
	Household drain may be clogged	<ul style="list-style-type: none"> • Check household plumbing. You may need to call a plumber.
	Drain hose siphoning; drain hose pushed too far down the drain	<ul style="list-style-type: none"> • Ensure there is an air gap between hose and drain.
Loud or unusual noise; vibration or shaking	Cabinet moving	<ul style="list-style-type: none"> • Washer is designed to move 1/4 " to reduce forces transmitted to the floor. This movement is normal.
	All rubber leveling legs are not firmly touching the floor	<ul style="list-style-type: none"> • Push and pull on the back right and then back left of your washer to check if it is level. If the washer is uneven, adjust the rubber leveling legs so they are all firmly touching the floor and locked in place. Your installer should correct this problem.
	Unbalanced load	<ul style="list-style-type: none"> • Open door and manually redistribute load. To check machine, run rinse and spin with no load. If normal, unbalance was caused by load.
	Pump clogged	<ul style="list-style-type: none"> • See page 26 on how to clean the Pump Filter.

	Problem	Possible Cause	What To Do
Washer Safety	No power/ washer not working or dead	Washer is unplugged	<ul style="list-style-type: none"> • Make sure cord is plugged securely into a working outlet.
Operation Requirements		Water supply is turned off	<ul style="list-style-type: none"> • Turn cold faucet fully on.
		Circuit breaker/fuse is tripped/blown	<ul style="list-style-type: none"> • Check house circuit breaker/fuses. Replace fuses or reset breaker. Washer should have separate outlet.
Installation Instructions	Snags, holes, tears, rips or excessive wear	Automatic self system checks	<ul style="list-style-type: none"> • First time the washer is plugged in, automatic checks occur. It may take up to 2 minutes before you can use your washer. This is normal operation.
Washer Use		Overloaded	<ul style="list-style-type: none"> • The dry weight of the load should be less than 18 lbs.
		Pens, pencils, nails, screws or other objects left in pockets	<ul style="list-style-type: none"> • Remove loose items from pockets.
		Pins, snaps, hooks, sharp buttons, belt buckles, zippers and sharp objects left in pockets	<ul style="list-style-type: none"> • Fasten snaps, hooks, buttons and zippers.
Washer Care	Control time wrong or changes	This is normal	<ul style="list-style-type: none"> • During spin the washer may need to rebalance the load sometimes to reduce vibrations. When this happens, the estimated time is increased causing time left to increase or jump.
Troubleshooting	Not enough water	This is normal	<ul style="list-style-type: none"> • Horizontal washers do not require the tub to fill with water like top-load washers.
	Washer pauses or has to be restarted, or washer door is locked and will not open	Pump clogged	<ul style="list-style-type: none"> • See page 26 on how to clean the Pump Filter.

Problem	Possible Cause	What To Do
Door unlocks or press ▶II and machine doesn't operate	This is normal	<ul style="list-style-type: none"> • Front-load washers start up differently than top-load washers, and it takes 30 seconds to check the system. The door will lock and unlock.
	Incorrect operation	<ul style="list-style-type: none"> • Simply open and close the door firmly; then press ▶II .
Water does not enter washer or enters slowly	Automatic self system checks	<ul style="list-style-type: none"> • After ▶II is pressed, the washer does several system checks. Water will flow 60 seconds after ▶II is pressed.
	Water supply is turned off Water valve screens are stopped up	<ul style="list-style-type: none"> • Turn on water supply. • Turn off the water source and remove the water connection hoses from the upper back of the washer. Use a brush or toothpick to clean the screens in the machine. Reconnect the hose and turn the water back on.
Wrinkling	Improper sorting	<ul style="list-style-type: none"> • Avoid mixing heavy items (like work clothes) with light items (like blouses).
	Overloading	<ul style="list-style-type: none"> • Load your washer so clothes have enough room to move freely.
	Incorrect wash cycle	<ul style="list-style-type: none"> • Match cycle selection to the type of fabric you are washing (especially for easy care loads).
	Repeated washing in water that is too hot	<ul style="list-style-type: none"> • Wash in warm or cold water.

	Problem	Possible Cause	What To Do
Washer Safety	Grayed or yellowed clothes	Not enough detergent	<ul style="list-style-type: none"> • Use correct amount of detergent. • Use HE detergent. • Use hottest water safe for fabric. • Use a water conditioner like Calgon brand or install a water softener. • Try a liquid detergent. • Sort clothes by color. If fabric label states wash separately unstable dyes may be indicated.
Operation Requirements		Not using HE (high-efficiency) detergent	
		Hard water	
		Detergent is not dissolving	
		Dye transfer	
Installation Instructions	Colored spots	Incorrect use of fabric softener	<ul style="list-style-type: none"> • Check fabric softener package for instructions and follow directions for using dispenser. • Sort whites or lightly colored items from dark colors. • Promptly remove wash load from washer.
Washer Use		Dye transfer	
Washer Care	Slight variation in metallic color	This is normal appearance	<ul style="list-style-type: none"> • Due to the metallic properties of paint used for this unique product, slight variations of color may occur due to viewing angles and lighting conditions.

Problem	Possible Cause	What To Do
Smell inside your washer	Washer unused for a long time, not using recommended quality of HE detergent or used too much detergent	<ul style="list-style-type: none"> • Run a Tub Clean cycle once a month. • In the case of strong smell, you may need to run the Tub Clean cycle more than once a month. • Use only the amount of detergent recommended on the detergent container. • Use only HE (high-efficiency) detergent. • Always remove wet items from the washer promptly after machine stops running. • Leave the door slightly open for the water to air dry. Close supervision is necessary if this appliance is used by or near children. Do not allow children to play on, with or inside this or any other appliance.
Detergent leak	Incorrect placement of detergent insert	Make sure detergent insert is properly located and fully seated. Never put detergent above max line.
Improper dispensing of softener or bleach	Dispenser clogged	Monthly clean the dispenser drawer to remove buildup of chemicals.
	Softener or bleach is filled above the max line	Make sure to have the correct amount of softener or bleach.
	Softener or bleach cap issue	Make sure softener and bleach cap for dispenser are seated or they will not work.

ERROR CODES

Description	Reason	Solution
E30	Door is not closed properly	Restart after the door is closed. Check if the clothes is stuck.
E10	Water injecting problem while washing	Check if the water pressure is too low. Straighten the water hoses. Check if the inlet valve filter is blocked.
E21	Overtime water draining	Check if the drain hose is blocked, clean drain filter.
E12	Water overflow	Restart the washer.
EXX	Others	Please try again first, call up service line if there are still troubles.

KOOLMORE LAUNDRY DRYER LIMITED WARRANTY

ATTACH YOUR RECEIPT HERE. PROOF OF PURCHASE IS REQUIRED TO OBTAIN WARRANTY SERVICE.

Please have the following information available when you call the Customer Service Center:

- Name, address and telephone number
- Model number and serial number
- A clear, detailed description of the problem
- Proof of purchase including dealer or retailer name and address

IF YOU NEED SERVICE:

1. Before contacting us to arrange service, please determine whether your product requires repair. Some questions can be addressed without service. Please take a few minutes to review the Troubleshooting section of the User Manual.
2. All warranty service is provided exclusively by our authorized Koolmore Service Providers in the U.S

Koolmore Customer Service

In the U.S.A. call 718-576-6342.

If outside the 50 States of the United States or Canada, contact your authorized Koolmore dealer to determine whether another warranty applies.

LIMITED WARRANTY

WHAT IS COVERED

FIRST YEAR LIMITED WARRANTY (PARTS AND LABOR)

For one year from the date of purchase, if this major appliance is installed, operated and maintained according to instructions attached to or furnished with the product, Koolmore Corporation (hereafter "Koolmore") will pay for factory specified replacement parts and repair labor to correct defects in materials or workmanship that existed when this major appliance was purchased, or at its sole discretion replace the product. In the event of product replacement, your appliance will be warranted for the remaining term of the original unit's warranty period.

YOUR SOLE AND EXCLUSIVE REMEDY UNDER THIS LIMITED WARRANTY SHALL BE PRODUCT REPAIR OR REPLACEMENT AS PROVIDED HEREIN. Service must be provided by a Koolmore designated service company. This limited warranty is valid only in the 50 States of the United States or Canada and applies only when the major appliance is used in the country in which it was purchased. This limited warranty is effective from the date of original consumer purchase. Proof of original purchase date is required to obtain service under this limited warranty.

LIMITED WARRANTY

WHAT IS NOT COVERED

1. Commercial, non-residential or multiple-family use, or use inconsistent with published user, operator or installation instructions.
2. In-home Instruction on how to use your product.
3. Service to correct improper product maintenance or installation, installation not in accordance with electrical codes or correction of household electrical system (i.e. house wiring, fuses, etc.).
4. Consumable parts (i.e. light bulbs, batteries, air or water filters, etc.).
5. Defects or damage caused by the use of non-genuine Koolmore parts or accessories.
6. Damage from accident, misuse, abuse, fire, floods, electrical issues, acts of God or use with products not approved by Koolmore.
7. Repairs to parts or systems to correct product damage or defects caused by unauthorized service, alteration or modification of the appliance.
8. Cosmetic damage including scratches, dents, chips, and other damage to appliance finishes unless such damage results from defects in materials and workmanship and is reported to Koolmore within 30 days.
9. Routine maintenance of the product.
10. Products that were purchased "as is" or as refurbished products.
11. Products that have been transferred from its original owner.
12. Discoloration, rust or oxidation of surfaces resulting from caustic or corrosive environments including but not limited to high salt concentrations, high moisture or humidity or exposure to chemicals.
13. Pick-up or delivery. This product is intended for in-home repair.
14. Travel or transportation expenses for service in remote locations where an authorized Koolmore servicer is not available.
15. Removal or reinstallation of inaccessible appliances or built-in fixtures (i.e. trim, decorative panels, flooring, cabinetry, islands, countertops, drywall, etc.) that interfere with servicing, removal or replacement of the product.
16. Service or parts for appliances with original model/serial numbers removed, altered or not easily identified.

The cost of repair or replacement under these excluded circumstances shall be borne by the customer.

DISCLAIMER OF IMPLIED WARRANTIES

IMPLIED WARRANTIES, INCLUDING ANY IMPLIED WARRANTY OF MERCHANTABILITY OR IMPLIED WARRANTY OF FITNESS FOR A PARTICULAR PURPOSE, ARE LIMITED TO ONE YEAR OR THE SHORTEST PERIOD ALLOWED BY LAW. Some states and provinces do not allow limitations on the duration of implied warranties of merchantability or fitness, so this limitation may not apply to you. This warranty gives you specific legal rights, and you also may have other rights that vary from state to state or province to province.

DISCLAIMER OF REPRESENTATIONS OUTSIDE OF WARRANTY

Koolmore makes no representations about the quality, durability, or need for service or repair of this major appliance other than the representations contained in this warranty. If you want a longer or more comprehensive warranty than the limited warranty that comes with this major appliance, you should ask Koolmore or your retailer about buying an extended warranty.

LIMITATION OF REMEDIES; EXCLUSION OF INCIDENTAL AND CONSEQUENTIAL DAMAGES

YOUR SOLE AND EXCLUSIVE REMEDY UNDER THIS LIMITED WARRANTY SHALL BE PRODUCT REPAIR AS PROVIDED HEREIN. KOOLMORE SHALL NOT BE LIABLE FOR INCIDENTAL OR CONSEQUENTIAL DAMAGES. Some states and provinces do not allow the exclusion or limitation of incidental or consequential damages, so these limitations and exclusions may not apply to you. This warranty gives you specific legal rights, and you also may have other rights that vary from state to state or province to province.



REGISTRATION INFORMATION

PROTECT YOUR PRODUCT:

We will keep the model number and date of purchase of your new Koolmore product on file to help you refer to this information in the event of an insurance claim such as fire or theft.

Register Online at www.koolmore.com

-Or-

Please fill out and return it to the following address:
Koolmore Supply, Inc. 383 Kingston Ave #365 Brooklyn, NY 11213

----- (detach here) -----

Name:	Model#: FLW-5CWH Serial #:
Address:	Date Purchased: Store / Dealer Name:
City: State: Zip:	E-mail Address:
Area Code: Phone Number:	Occupation:
Did you purchase an additional warranty:	As your Primary Residence:
How did you learn about this product: <input type="checkbox"/> Advertising <input type="checkbox"/> In Store Demo <input type="checkbox"/> Personal Demo	Age: Marital Status:

Information collected or submitted to us is only available to company internal employees for purposes of contacting you or sending you emails, based on your request for information and to company service providers for purposes of providing services relating to our communications with you. All data will not be shared with other organizations for commercial purposes.

Please consider leaving a customer review at www.koolmore.com.

Koolmore Supply, Inc.
383 Kingston Ave #365
Brooklyn, NY 11213
Customer Service 718-576-6342

Made in China