



SPEC SHEET

KoolMore 48 in. Commercial 4-Burner Natural Gas Charbroiler with 120,000 BTU in Stainless-Steel

Model: KM-GCB4-48M

FEATURES

- Professional-Grade Charbroil Grill
- Heavy-Duty Cast Iron Grates
- Classic Temperature Control Knobs
- Mess-Free Drip Tray
- ETL Listed for Safety and Sanitation
- Convertible to LP, Kit included.



CLOSE UP IMAGES

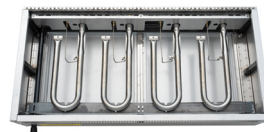
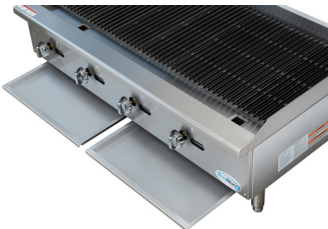
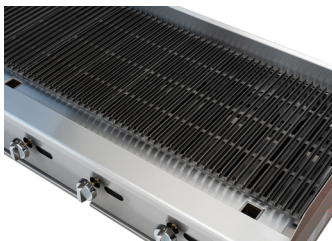

TECHNICAL SPECS

Dimensions

Length	47.4
Width	26.2
Height	16
Weightlbs	198
Installation Type	Countertop
Cooking Surface Width	46.93
Cooking Surface Depth	18.31
Cooking Area Sq	859.29

Features & Materials

Control Type	Manual
Control Location	Front
Number Of Temperature Cooking Controls	4
Backsplash Size	4.8
Number Of Burners	4
Btu Per Burner	30000
Types Of Burners	U-shaped burners
Exterior Material	Stainless-Steel 430
Color Finish	Silver
Number Of Grates	8
Burner Grate Material	Cast Iron
Grate Thickness	0.83
Dishwasher Safe Grates	Yes
Cooktop Surface Type	Gas
Feature One	Cast iron straight grates
Feature Two	Even heat distribution
Feature Three	4" heavy duty stainless steel legs
Feature Four	U-shaped stainless steel burner design allows for efficient heat distribution and faster heat recovery
Feature Five	Cool touch bull-nose design protects user from hot surfaces
Feature Six	Welded in place stainless steel side splash installed
Feature Seven	Option to angle grates for better cooking and heat distribution

Gas Info & Certifications

Fuel Type	Natural Gas
Gas Inlet Size	0.75
Convertible	Convertible to LP, Kit included.
Certifications	ETL Listed for Safety and Sanitation

Plan View

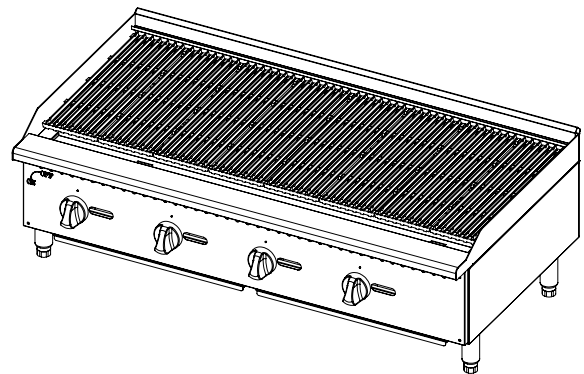
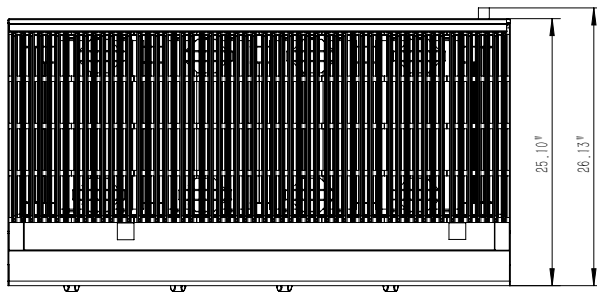
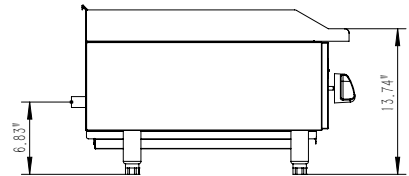
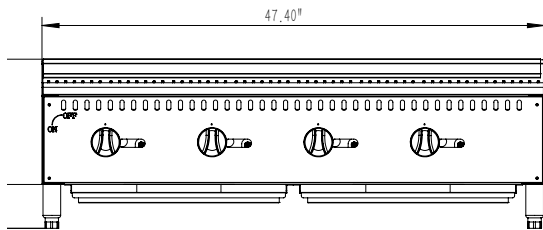

CERTIFICATIONS



706 Eastern Parkway STE 1G, Brooklyn NY 11213
718-576-6342
info@koolmore.com