

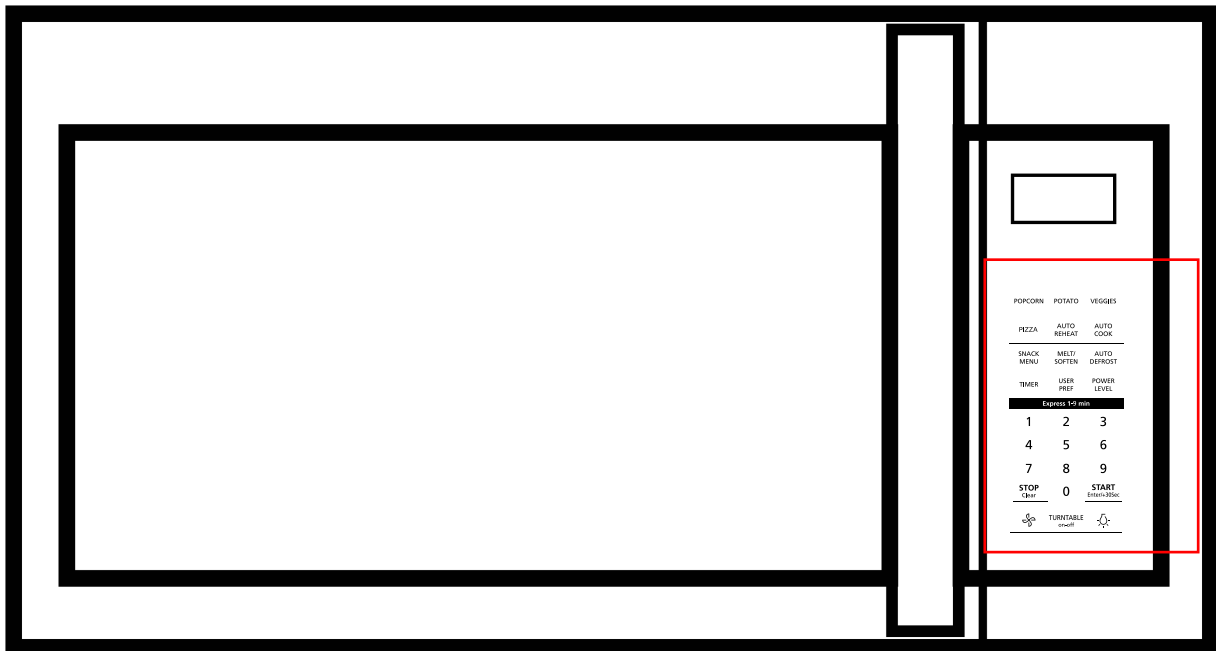

# User's Manual

1.9 Cu.Ft. Over the Range Stainless Steel Microwave

**MODEL: KM-MOT-2SS**



**BEFORE USING YOUR PRODUCT:** Please read this manual carefully & follow all safety rules & operating instructions. Keep this manual for future reference.

### Read This Manual

Inside you will find many helpful hints on how to use and maintain your unit properly. Just a little preventative care on your part can save you a great deal of time and money over the life of your microwave oven. You'll find many answers to common problems in the chart of troubleshooting tips. If you review the chart of Troubleshooting Tips first, you may not need to call for service.

**For any service-related Issues, please contact us:**

Phone Number: 718-576-6342

Email address: support@koolmore.com

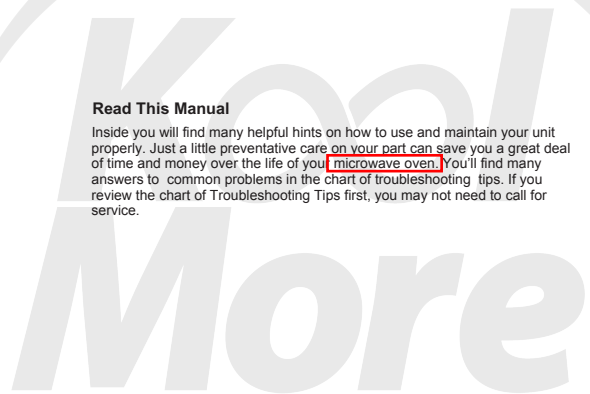

# PRECAUTIONS TO AVOID POSSIBLE EXPOSURE TO EXCESSIVE MICROWAVE ENERGY

- (a) Do not attempt to operate this oven with the door open since open door operation can result in harmful exposure to microwave energy.  
It is important not to defeat or tamper with the safety interlocks.
- (b) Do not place any object between the oven front face and the door or allows soil or cleaner residue to accumulate on sealing surfaces.
- (c) Do not operate the oven if it is damaged. It is particularly important that the oven door close properly and that there is no damage to the:
  - (1) DOOR (bent)
  - (2) HINGES AND LATCHES (broken or loosened)
  - (3) DOOR SEALS AND SEALING SURFACES
- (d) The oven should not be adjusted or repaired by anyone except properly qualified service personnel.

## Specifications

Model:	KM-MOT-2SS
Rated Voltage:	120V~60Hz
Rated Input Power(Microwave):	1500 W
Rated Output Power(Microwave):	1000 W

# IMPORTANT SAFETY INSTRUCTIONS

When using electrical appliances basic safety precautions should be followed, including the following:

**WARNING** - To reduce the risk of burns, electric shock, fire, injury to persons or exposure to excessive microwave energy:

1. Read all instructions before using the appliance.
2. Read and follow the specific: "PRECAUTIONS TO AVOID POSSIBLE EXPOSURE TO EXCESSIVE MICROWAVE ENERGY" found on page 2.
3. This appliance must be grounded. Connect only to properly grounded outlet. See "GROUNDING INSTRUCTIONS" found on page 4.
4. Install or locate this appliance only in accordance with the provided installation instructions.
5. Some products such as whole eggs and sealed containers - for example, closed glass jars - are able to explode and should not be heated in this oven.
6. Use this appliance only for its intended use as described in the manual. Do not use corrosive chemicals or vapors in this appliance. This type of oven is specifically designed to heat, cook or dry food. It is not designed for industrial or laboratory use.
7. As with any appliance, close supervision is necessary when used by children.
8. Do not operate this appliance if it has a damaged cord or plug, if it is not working properly, or if it has been damaged or dropped.
9. This appliance should be serviced only by qualified service personnel. Contact nearest authorized service facility for examination, repair, or adjustment.
10. Do not cover or block any openings on the appliance.
11. Do not store this appliance outdoors. Do not use this product near water - for example, near a kitchen sink, in a wet basement, near a swimming pool, or similar location.
12. Do not immerse cord or plug in water.
13. Keep cord away from heated surface.
14. Do not let cord hang over edge of table or counter.
15. When cleaning surfaces of door and oven that comes together on closing the door, use only mild, nonabrasive soaps, or detergent applied with a sponge or soft cloth.
16. To reduce the risk of fire in the oven cavity:
  - 1). Do not overcook food. Carefully attend appliance when paper, plastic, or other combustible materials are placed inside the oven to facilitate cooking.
  - 2). Remove wire twist-ties from paper or plastic bag before placing bag in oven.
  - 3). If material inside of the oven ignite, keep oven door closed, turn oven off, and disconnect the power cord, or shut off power at the fuse or circuit breaker panel.
  - 4). Do not use the cavity for storage purposes. Do not leave paper products, cooking utensils, or food in the cavity when not in use.
17. Liquids, such as water, coffee, or tea are able to be overheated beyond the boiling point without appearing to be boiling. Visible bubbling or boiling when the container is removed from the microwave oven is not always present.

THIS COULD RESULT IN VERY HOT LIQUID SUDDENLY BOILING OVER WHEN THE CONTAINER IS DISTURBED OR A UTENSIL IS INSERTED INTO THE LIQUID.

To reduce the risk of injury to persons:

- 1) Do not overheat the liquid.
- 2) Stir the liquid both before and halfway through heating it.
- 3) Do not use straight-sided containers with narrow necks.
- 4) After heating, allow the container to stand in the microwave oven for a short time before removing the container.
- 5) Use extreme care when inserting a spoon or other utensil into the container.
18. Do not operate any heating or cooking appliance beneath the appliance.  
(Exception: A microwave oven investigated for use above another heating appliance.)
19. Do not mount unit over or near any portion of heating or cooking appliance.  
(Exception: A microwave oven investigated for use above another heating appliance.)
20. Do not mount over sink.
21. Do not store anything directly on top of the appliance surface when the appliance is in operation.
22. Clean Ventilation Hoods Frequently - Grease should not be allowed to accumulate on hood or filter.
23. When flaming foods under the hood, turn the fan on.
24. Use care when cleaning the vent-hood filter. Corrosive cleaning agents, such as lye-based oven cleaners, may damage the filter.
25. Suitable for use above both gas and electric cooking equipment.

## SAVE THESE INSTRUCTIONS

## GROUNDING INSTRUCTIONS

This appliance must be grounded. In the event of an electrical short circuit, grounding reduces the risk of electric shock by providing an escape wire for the electric current. This appliance is equipped with a cord having a grounding wire with a grounding plug. The plug must be plugged into an outlet that is properly installed and grounded.

**WARNING** - Improper use of the grounding can result in a risk of electric shock.

Consult a qualified electrician or serviceman if the grounding instructions are not completely understood, or if doubt exists as to whether the appliance is properly grounded. If it is necessary to use an extension cord, use only a 3-wire extension cord that has a 3-blade grounded plug, and 3-slot receptacle that will accept the plug on the appliance. The marked rating of the extension cord shall be equal to or greater than the electrical rating of the appliance.

**DANGER** - Electric Shock Hazard

Touching some of the internal components can cause serious personal injury or death. Do not disassemble this appliance.

**WARNING** - Electric Shock Hazard

Improper use of the grounding can result in electric shock. Do not plug into an outlet until appliance is properly installed and grounded.

1. A short power-supply cord is provided to reduce the risks resulting from becoming entangled in or tripping over a longer cord.
2. Longer cord sets or extension cords are available and may be used if care is exercised in their use.
3. If a long cord or extension cord is used:
  - 1) The marked electrical rating of the cord set or extension cord should be at least as great as the electrical rating of the appliance.
  - 2) The extension cord must be a grounding-type 3-wire cord.
  - 3) The longer cord should be arranged so that it will not drape over the counter top or tabletop where it can be pulled on by children or tripped over unintentionally.

## RADIO INTERFERENCE

1. Operation of the microwave oven may cause interference to your radio, TV or similar equipment.
2. When there is interference, it may be reduced or eliminated by taking the following measures:
  - 1) Clean door and sealing surface of the oven
  - 2) Reorient the receiving antenna of radio or television.
  - 3) Relocate the microwave oven with respect to the receiver.
  - 4) Move the microwave oven away from the receiver.
  - 5) Plug the microwave oven into a different outlet so that microwave oven and receiver are on different branch circuits.

**This device complies with part 18 of the FCC Rules.**

# UTENSILS

## CAUTION - Personal Injury Hazard

Tightly-closed utensils could explode. Closed containers should be opened and plastic pouches should be pierced before cooking.

See the instructions on "Materials you can use in microwave oven or to be avoided in microwave oven."

There may be certain non-metallic utensils that are not safe to use for microwaving. If in doubt, you can test the utensil in question following the procedure below.

### Utensil Test:

1. Fill a microwave-safe container with 1 cup of cold water (250ml) along with the utensil in question.
2. Cook on maximum power for 1 minute.
3. Carefully feel the utensil. If the empty utensil is warm, do not use it for microwave cooking.
4. Do not exceed 1 minute cooking time.

## Materials you can use in microwave oven

Utensils	Remarks
Browning dish	Follow manufacturer's instructions. The bottom of browning dish must be at least 3/16 inch (5mm) above the turntable. Incorrect usage may cause the turntable to break.
Dinnerware	Microwave-safe only. Follow manufacturer's instructions. Do not use cracked or chipped dishes.
Glass jars	Always remove lid. Use only to heat food until just warm. Most glass jars are not heat resistant and may break.
Glassware	Heat-resistant oven glassware only. Make sure there is no metallic trim. Do not use cracked or chipped dishes.
Oven cooking bags	Follow manufacturer's instructions. Do not close with metal tie. Make slits to allow steam to escape.
Paper plates and cups	Use for short term cooking/warming only. Do not leave oven unattended while cooking.
Paper towels	Use to cover food for reheating and absorbing fat. Use with supervision for a short-term cooking only.
Parchment paper	Use as a cover to prevent splattering or a wrap for steaming.

## Materials you can use in microwave oven

Utensils	Remarks
Plastic	Microwave-safe only. Follow the manufacturer's instructions. Should be labeled "Microwave Safe". Some plastic containers soften, as the food inside gets hot. "Boiling bags" and tightly closed plastic bags should be slit, pierced or vented as directed by package.
Plastic wrap	Microwave-safe only. Use to cover food during cooking to retain moisture. Do not allow plastic wrap to touch food.
Thermometers	Microwave-safe only (meat and candy thermometers).
Wax paper	Use as a cover to prevent splattering and retain moisture.

## Materials to be avoided in microwave oven

Utensils	Remarks
Aluminum tray	May cause arcing. Transfer food into microwave-safe dish.
Food carton with metal handle	May cause arcing. Transfer food into microwave-safe dish.
Metal or metal-trimmed utensils	Metal shields the food from microwave energy. Metal trim may cause arcing.
Metal twist ties	May cause arcing and could cause a fire in the oven.
Paper bags	May cause a fire in the oven.
Plastic foam	Plastic foam may melt or contaminate the liquid inside when exposed to high temperature.
Wood	Wood will dry out when used in the microwave oven and may split or crack.

# PART NAMES

## FRONT VIEW

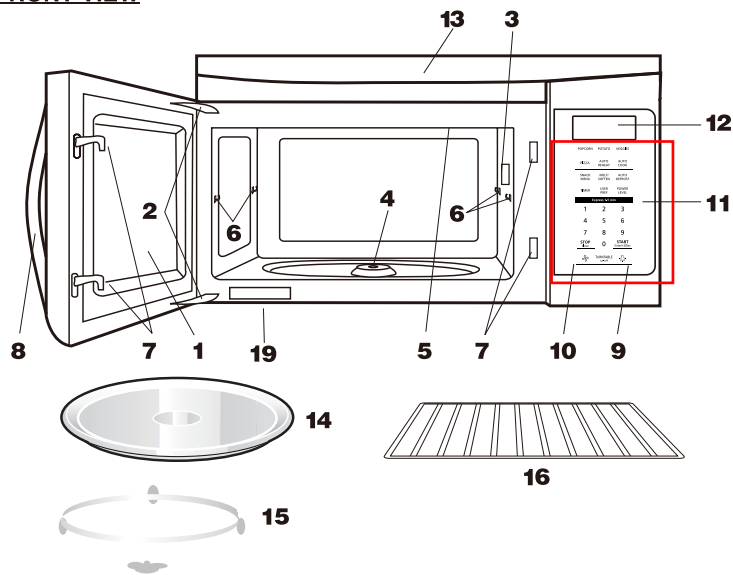

## BOTTOM VIEW

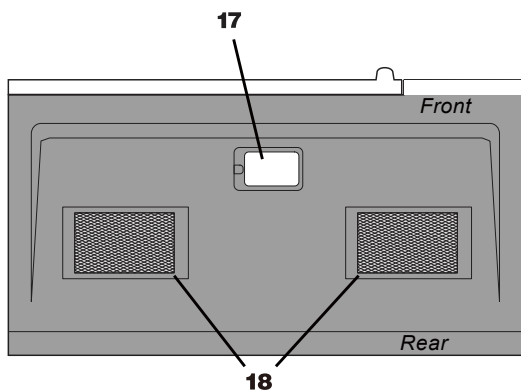

- 1 Microwave oven door with see-through window
- 2 Door hinges
- 3 Waveguide cover:  
DO NOT REMOVE.
- 4 Turntable motor shaft
- 5 Microwave oven light  
It will light when microwave oven is operating or door is open.
- 6 Rack holders
- 7 Safety door latches  
The microwave oven will not operate unless the door is securely closed.
- 8 Handle
- 9 Light hi/lo/off pad  
Press the **light hi/lo/off** pad once for high, twice for low and three times to turn off the light.
- 10 Vent hi/lo/off pad  
Press the **vent hi/lo/off** pad once for high speed, twice for low speed and three times to turn off the fan.
- 11 Auto-Touch control panel
- 12 Time display: Digital display, 99 minutes, 99 seconds
- 13 Ventilation openings
- 14 Removable turntable  
The turntable will rotate clockwise or counter-clockwise. Only remove for cleaning.
- 15 Removable turntable support  
First, carefully place the turntable support in the motor shaft in the center of the microwave oven floor. Place the support ring on the microwave oven floor. Then, place the turntable on the turntable support securely.
- 16 Rack for 2-level cooking/ reheating
- 17 Light cover
- 18 Grease filters
- 19 Menu label

# CONTROL PANEL

The 7-digit Interactive Display spells out operating steps and shows cooking hints.

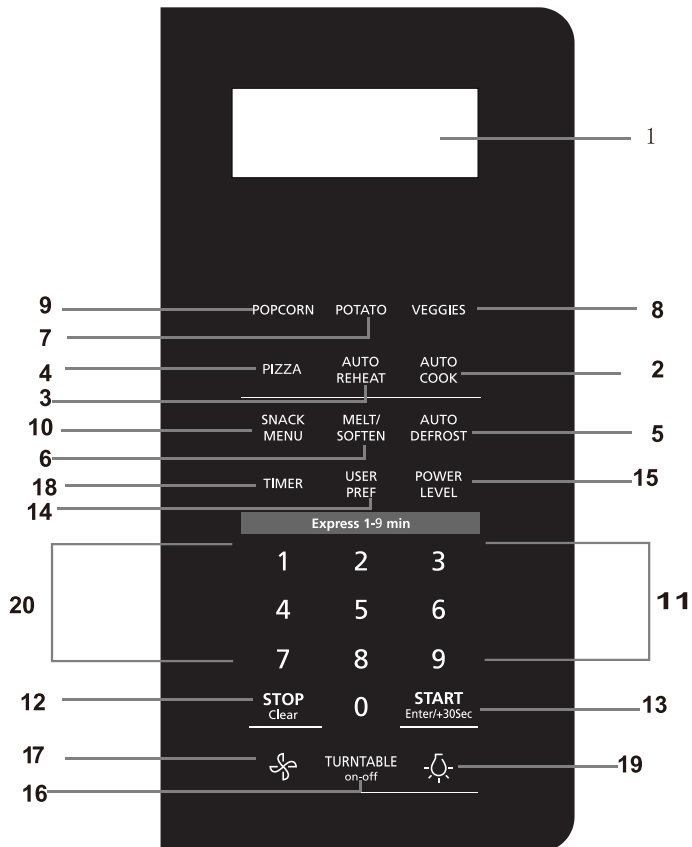
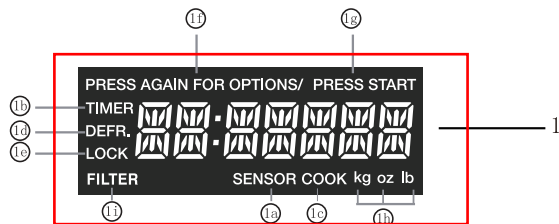

Number next to the control panel key illustration indicates pages on which there are feature descriptions and usage information.

## (1) Display:

The display includes a clock and indicators that show the time of day, cooking time settings, cook powers, sensor, quantities, weights and cooking functions selected.

### 1a. SENSOR:

Icon displayed when using sensor cook.

### 1b. TIMER:

Icon displayed when timer is being set or running.

### 1c. COOK:

Icon displayed when starting microwave cooking.

### 1d. DEFR:

Icon displayed when defrosting food.

### 1e. LOCK:

Icon displayed in control lock.

### 1f. PRESS AGAIN FOR OPTIONS:

Icon displayed when additional options are available.

### 1g. PRESS START:

Icon displayed when a valid function can be started.

### 1h. kg, oz, lb:

Icon displayed when choosing the weight.

### 1i. FILTER:

Icon displayed replace PureAir® Filter.

### (2) Auto Cook

### (3) Auto Reheat

### (4) Pizza

### (5) Auto Defrost

### (6) Melt /Soften

### (7) Potato (1-4 potatoes)

### (8) Veggies

### (9) Popcorn

### (10) Snack menu

### (11) Numeric pads (0 thru 9)

### (12) Stop/Clear

### (13) START Enter /+30sec

### (14) User pref

### (15) Power Level (11 power levels available)

### (16) Turntable (On-Off)

### (17) Exhaust (High/Low/Off)

Use to turn the exhaust fan off, or to adjust fan speed.

### (18) Timer (On-Off)

### (19) Surface Light (High/Low/Off)

Press this pad to adjust the brightness of surface lights.

### (20) Quick Start (9 instant key settings)



- Before operating your new oven make sure you read and understand this Use and Care Guide completely.
- The clock can be disabled when the microwave is first plugged in and the STOP key is selected.  
To re-enable the clock follow clock instructions.

### To Set the Clock

- Suppose you want to enter the correct time of day 10:59

Touch:	Display Shows:
1. USER PREF	12:00 ENTER TIME <small>PRESS AGAIN FOR OPTIONS/</small>
2. (1) (0) (5) (9)	10:59 <small>PRESS START</small>
3. <b>START</b> Enter/+30Sec	10:59

### NOTE

1. If you begin to enter in an incorrect time (e.g. 2:89) the 8 is an invalid digit and cannot be entered. Enter the correct time.
2. If you touch **STOP** while setting the clock, the display will show the last time of day set or a blank display if no time of day has been set.

### STOP clear

Press the **STOP** Clear to:

1. Erase if you make a mistake during programming.
2. Cancel timer setting and the signal after cooking.
3. Stop the oven temporarily during cooking.
4. Return the time of day to the display.
5. Cancel a program during cooking, press twice.

## MANUAL COOKING

### Time Cooking

Your Over the Range Microwave Oven can be programmed for 99 minutes 99 seconds (99 :99). Always enter the seconds after the minutes, even if they are both zeros.

- Suppose you want to cook for 5 minutes, 30 seconds at 100% power,

Touch:	Display Shows:
1. (5) (3) (0)	5:30 <small>PRESS START</small>
2. <b>START</b> Enter/+30Sec	5:30 Time counting down <small>COOK</small>

### Using One Touch Start

This is a time saving pad that will automatically start cooking 2 seconds after selected. Numeric key 1, 2, or 9 can be touched for a 1 minute, 2 minute or 9 minute to start cooking feature.

Touch:	Display Shows:
1. (2)	2:00 <small>COOK</small> Time counting down

### Interrupting Cooking

You can stop the oven during a cycle by opening the door. The oven stops heating and the fan turns off, but the light stays on.

To restart cooking, close the door and touch

**START**  
Enter/+30Sec

If you do not want to continue cooking, open the door and touch **STOP**  
Clear

# MANUAL COOKING

## Using Add 30 Sec.

This is a time-saving pad. It is a simplified feature that lets you quickly set and start microwave cooking at 100% power.

- Suppose you want to cook for one minute.

Touch:	Display Shows:
1. <b>START</b> Enter/+30Sec	:30 <small>COOK</small>
2. <b>START</b> Enter/+30Sec	1:00 <small>COOK</small> Time counting down

### NOTE

"Food" will be displayed if a quick start cooking cycle or +30 sec key is not selected within 5 minutes of placing food in the microwave. You must open then close the door again to clear "Food" from the display.

## Setting Timed Cooking With Power Level

This feature lets you program a specific cooking time and power. For best results, there are 10 power level settings in addition to HIGH (100%) power.

- Suppose you want to cook for 5 minutes, 30 seconds at 80% power.

Touch:	Display Shows:
1. (5) (3) (0)	5:30 <small>PRESS START</small>
2. POWER LEVEL x 3	PL-80 <small>PRESS START</small>
3. <b>START</b> Enter/+30Sec	5:30 <small>COOK</small> Time counting down

### NOTE

If you do not select a power level, the oven will automatically cook at HIGH (100%) power.

## Setting Two-Stage Cooking

For best results, some recipes call for different power levels during a cook cycle. You can program your oven for two power level stages during the cooking cycle.

- Suppose you want to set a 2-stage cook cycle. The first stage is a 3 minute cook time at 80% cook power then a 7 minute cook time at 50% cook power.

Touch:	Display Shows:
1. (3) (0) (0)	3:00 <small>PRESS START</small> To set a 3 minute cooking time for first stage.
2. POWER LEVEL x 3	PL-80 <small>PRESS START</small>
3. (7) (0) (0)	7:00 <small>PRESS START</small> To set a 7 minute cooking power for the second stage.
4. POWER LEVEL x 6	PL-50 <small>PRESS START</small>

### NOTE

You can program a "0" power second stage for standing time inside the oven.

5. <b>START</b> Enter/+30Sec	3:00 <small>COOK</small> Time counting down
---------------------------------	---

# MANUAL COOKING

## To Set Power Level

There are eleven preset power levels.

Using lower power levels increases the cooking time which is recommended for foods such as cheese, milk and long slow cooking of meats. Consult cookbook or recipes for specific recommendations.

PRESS POWER LEVEL PAD NUMBER OF TIMES FOR DESIRED POWER	APPROXIMATE PERCENTAGE OF POWER	COMMON WORDS FOR POWER LEVELS
POWER LEVEL x 1	100%	High
POWER LEVEL x 2	90%	
POWER LEVEL x 3	80%	
POWER LEVEL x 4	70%	Medium High
POWER LEVEL x 5	60%	
POWER LEVEL x 6	50%	Medium
POWER LEVEL x 7	40%	
POWER LEVEL x 8	30%	Med Low/Defrost
POWER LEVEL x 9	20%	
POWER LEVEL x 10	10%	Low
POWER LEVEL x 11	0%	

## Using the Rack

The rack allows several foods to be cooked or reheated at one time. However, for the best cooking and reheating, use Turntable ON function and cook with SENSOR COOKING or AUTO COOKING without the rack. When the rack is used, set time and power level manually. Allow plenty of space around and between the dishes. Pay close attention to the cooking and reheating progress. Reposition the foods and reverse them from the rack to turntable and/or stir them at least once during any cooking or reheating time. After cooking or reheating, stir if possible. Using a lower power level will assist in better cooking and reheating uniformity.

### Avoid:

- Storing the rack in the microwave oven when not in use.
- Popping popcorn with the rack in the microwave oven.
- Using any browning dish on the rack.
- Using SENSOR COOKING and AUTO COOKING with the rack.
- Cooking directly on the rack—use microwave-safe cookware.



### NOTE

Turntable on/off function can be used in Manual Operation. See page 26.

## Manual Defrost

If the food that you wish to defrost is not listed on the Defrost chart or is above or below the limits in the Amount column on the Defrost chart (see page 20-21), you need to defrost manually.

You can defrost any frozen food, either raw or previously cooked, by using power level for 30%.

For either raw or previously cooked frozen food the rule of thumb is approximately 4 minutes per pound. For example, defrost 4 minutes for 1 pound of frozen spaghetti sauce.

Always stop the oven periodically to remove or separate the portions that are defrosted. If food is not defrosted at the end of the estimated defrosting time, program the oven in 1 minute increments on power level 30% until totally defrosted.

When using plastic containers from the freezer, defrost only long enough to remove from the plastic in order to place in a microwave-safe dish.

# ONE TOUCH COOK

## Popcorn

Press "Popcorn" key and LED displays 3.3 oz. and the "PRESS AGAIN FOR OPTIONS" icon. You can press "Popcorn" key again to select 3.0 oz. or 1.75 oz.. You also can press number keys to choose the weight of pizza(1-3.3 oz., 2-3.0 oz., 3-1.75 oz. )

- Suppose you want to cook 3.3 oz. popcorn.

Touch: \_\_\_\_\_ Display Shows: \_\_\_\_\_

1. POPCORN

PRESS AGAIN FOR OPTIONS/ PRESS START  
3.3  
oz

2. **START**  
Enter/+30Sec

POPCORN  
COOK  
Time counting down

## Veggies

There are 2 options (Frozen Vegetables, Fresh Vegetables) under the Veggies.

- Suppose you want to cook two cups of frozen veggies.

Touch: \_\_\_\_\_ Display Shows: \_\_\_\_\_

1. VEGGIES

PRESS AGAIN FOR OPTIONS/ PRESS START  
FRESH

2. VEGGIES

PRESS AGAIN FOR OPTIONS/ PRESS START  
FROZEN

3. **START**  
Enter/+30Sec

FROZEN VEGGIES  
COOK  
Time counting down

### Vegetables chart

FOOD (Initial temperature)	AMOUNT	PROCEDURE
1. Frozen Veggies (-18 °C)	2 Cups	Add no water. Cover with lid or plastic wrap. Press the <b>VEGGIES</b> pad two times for Frozen Vegetables . After cooking, stir and let stand, covered, for 3 minutes.
2. Fresh Veggies (5 °C) Broccoli Brussels sprouts Cabbage Cauliflower (flowerets) Cauliflower (whole) Spinach Zucchini	2 Cups	Wash and place in casserole. Add no water if vegetables have just been washed. Cover with lid for tender vegetables. Use plastic wrap for tender-crisp vegetables. Press the <b>VEGGIES</b> pad one time for fresh Vegetables. After cooking, stir, if possible. Let stand, covered, for 2 to 5 minutes.
Carrots, sliced Corn on cob Green beans Winter squash - diced - halves		Place in casserole. Add 1-4 tbsp. water. Cover with lid for tender vegetables. Use plastic wrap cover for tender-crisp vegetables. Press the <b>VEGGIES</b> pad one time for fresh vegetables. After cooking stir, if possible. Let stand, covered, for 2 to 5 minutes.

Amount	Press popcorn pad
3.3 oz.	once
3.0 oz.	2 times
1.75 oz.	3 times

## NOTES

1. Remove the metal shelf from microwave oven when cooking popcorn. Do not use regular paper bags. Do not re-pop unpopped kernals. Do not cook popcorn in glass cookware.

# ONE TOUCH COOK

## Snack Menu

Snack Menu is for cooking/heating foods that take a short amount of time!

- Suppose you want to reheat 3 hotdogs.

Touch:	Display Shows:
1. SNACK MENU	<small>PRESS AGAIN FOR OPTIONS/ PRESS START</small> HOT 3005
2. <b>START</b> Enter/+30Sec	1-6

3. 3

PRESS START  
3

4. **START**  
Enter/+30Sec

HOT 3005  
COOK  
Time counting down

## Snack Menu chart

FOOD	AMOUNT	PROCEDURE
1. Hot Dogs	1 - 6 Pieces	Place hot dog in bun. Wrap each with paper towel or napkin.
2. Meal in a Cup	2.39 oz	This setting is ideal for individual portions of canned food packed in a small microwaveable container, usually 6 to 8 ounces. Remove inner metal lid and replace outer microwaveable lid. After cooking, stir food and allow to stand 1 or 2 minutes.
3. Frozen Kid's Meal	1 - 2 Servings	Use this pad for frozen, convenience foods. It will give satisfactory results for most brands. You may wish to try several and choose your favorite. Remove package from outer wrapping and follow package directions for covering. After cooking, let stand, covered for 1 to 3 minutes.

**Potato**

- Suppose you want to cook 1 to 4 baked Potatoes.

Touch:

Display Shows:

1. POTATO

2. **START**  
Enter/+30Sec



**NOTES**

1. Cooking times are based on an average 8 ounce potato.

**Baked Potato chart**

FOOD	AMOUNT	PROCEDURE
Potato*	1 - 4 servings	Pierce with fork in several places. Place on paper towel on turntable. After cooking, remove from oven and let stand for 5 minutes.

\* It is not necessary to enter amount or number.

**Pizza**

Press "Pizza" key and LED displays 6 oz. and the "PRESS AGAIN FOR OPTIONS" icon. You can press "Pizza" key again to select 8 oz. pizza or press "1" or "2" to select 6 oz. or 8 oz.

- Suppose you want to cook a 6.0 oz. pizza.

Touch:

Display Shows:

1. PIZZA

2. **START**  
Enter/+30Sec



Amount	Press pizza pad
6.0 oz.	once
8.0 oz.	2 times

# ONE TOUCH COOK

## Setting Melt/Soften

The oven uses low power to melt and soften items. See the following table.

- Suppose you want to melt 2 sticks of Butter.

Touch:	Display Shows:
1. MELT/ SOFTEN	<small>PRESS AGAIN FOR OPTIONS/ PRESS START</small> MELT BUTTER
2. <b>START</b> Enter/+30Sec	ENTER 1-2 STK
3. ②	<small>PRESS START</small> 2 STICK
4. <b>START</b> Enter/+30Sec	MELT BUTTER <small>COOK</small> Time counting down

## MELT TABLE

CATEGORY	AMOUNT	DIRECTION
BUTTER	1 or 2 sticks	Unwrap and place in microwavable container. No need to cover butter. Stir at the end of cooking to complete melting.
CHOCOLATE	2, 4 or 8 oz.	Chocolate chips or squares of baking chocolate may be used. Unwrap squares and place in microwavable container. Stir at the end of cycle to complete melting.
SOFTEN ICE CREAM	Pint, 1.5 Quart.	Place container in oven. Ice cream will be soft enough to make scooping easier.
SOFTEN CREAM CHEESE	3 or 8 oz.	Unwrap and place in microwavable container. Cream cheese will be at room temperature and ready for use in recipe.





# AUTO REHEAT

## Auto reheat

Key	Food	Amount
Auto reheat x1	Beverage	1 - 3 Cups
Auto reheat x2	Dinner Plate	1 - 2 Plates
Auto reheat x3	Soup/Sauce	-
Auto reheat x4	Casserole	-
Auto reheat x5	Rolls	1 - 3 Slices

## <Quick Meals>

- Suppose you want to reheat 2 cups of beverage

Touch:	Display Shows:
1. <b>AUTO REHEAT</b> 	<small>PRESS AGAIN FOR OPTIONS/ PRESS START</small> BEVERAGE 
2. <b>START</b> Enter/+30Sec	ENTER 1-3 CUP
3. 	<small>PRESS START</small> 2 CUPS
4. <b>START</b> Enter/+30Sec	BEVERAGE  <small>COOK</small> Time counting down

# AUTO COOKING

## Auto Cook

Key	Food	Amount
Auto Cook x1	Bacon	1 - 3 Slices
Auto Cook x2	Frozen Dinner	10Oz/20Oz
Auto Cook x3	Rice	1 - 2 Cups
Auto Cook x4	Frozen Breakfast	8Oz/12Oz

## <Quick Meals>

- Suppose you want to cook Frozen Dinner for 1 serving .

Touch:	Display Shows:
1. <b>AUTO COOK</b>	<small>PRESS AGAIN FOR OPTIONS/ PRESS START</small> <b>BACON</b>
2. <b>AUTO COOK</b>	<small>PRESS AGAIN FOR OPTIONS/ PRESS START</small> <b>FROZEN DINNER</b>
3. <b>START</b> Enter/+30Sec	<b>ENTER 1-2</b>
4. <b>②</b>	<small>PRESS START</small> <b>20</b> <small>oz</small>
5. <b>START</b> Enter/+30Sec	<b>FROZEN DINNER</b> <small>COOK</small> Time counting down

## NOTES

When AUTO COOKING is selected, Turntable On is automatically set for optimum cooking.

# AUTO DEFROST

## Using Auto Defrost

The auto defrost feature provides you with the best defrosting method for frozen foods. The cooking guide will show you which defrost sequence is recommended for the food you are defrosting.

For added convenience, the Auto Defrost includes a built-in beep mechanism that reminds you to check, turn over, separate, or rearrange the food in order to get the best defrost results. Three different defrosting levels are provided:

1. MEAT
2. POULTRY
3. FISH

Available weight is 0.1-6.0 lbs

- Suppose you want to defrost 1.2 lbs of fish.

Touch:	Display Shows:
1. <b>AUTO DEFROST</b>	<small>PRESS AGAIN FOR OPTIONS/ PRESS START</small> <b>MEAT</b>
2. <b>AUTO DEFROST</b>	<small>PRESS AGAIN FOR OPTIONS/ PRESS START</small> <b>POULTRY</b>
3. <b>AUTO DEFROST</b>	<small>PRESS AGAIN FOR OPTIONS/ PRESS START</small> <b>FISH</b>
4. <b>START</b> Enter/+30Sec	<b>ENTER WEIGHT</b> lb
5. <b>1</b> and <b>2</b>	<b>1.2</b> lb
To enter weight	
6. <b>START</b> Enter/+30Sec	<small>DEFRL.</small> <b>FISH</b> <small>COOK</small> Time counting down

### NOTES

The oven will beep during the DEFROST cycle. At this time, open the door and turn, separate, or rearrange the food. Remove any portions that have thawed. Return frozen portions to the oven and touch **START** to resume the defrost cycle.

## Operating Tips

- For best results, remove fish, shell fish, meat and poultry from its original closed paper or plastic package (wrapper). Otherwise, the wrap will hold steam and juice close to the foods, which can cause the outer surface of the foods to cook.
- For best results, roll your ground meat into a ball before freezing. During the DEFROST cycle, the microwave will signal when it is time to turn the meat over. Scrape off any excess frost from the meat and continue defrosting.
- Place foods in a shallow container or on a microwave roasting rack to catch drippings.

This table shows food type selections and the weights you can set for each type. For best results, loosen or remove covering on food.

KEYPRESS	Category	WEIGHTS YOU CAN SET (tenths of a pound)
Auto Defrost x 1	Meat	0.1 to 6.0 lbs
Auto Defrost x 2	Poultry	0.1 to 6.0 lbs
Auto Defrost x 3	Fish	0.1 to 6.0 lbs

## Weight conversion table

You are probably used to measuring food in pounds and ounces that are fractions of a pound (for example, 4 ounces equals 1/4 pound). However, in order to enter food weight in Auto Defrost, you must specify pounds and tenths of a pound.

If the weight on the food package is in fractions of a pound, you can use the following table to convert the weight to decimals.

Equivalent Weight	
OUNCES	DECIMAL WEIGHT
1.6	.10
3.2	.20
4.0	.25 One-Quarter Pound
4.8	.30
6.4	.40
8.0	.50 One-Half Pound
9.6	.60
11.2	.70
12.0	.75 Three-Quarters Pound
12.8	.80
14.4	.90
16.0	1.0 One Pound

### NOTES

If between two decimal weights, choose the lower weight for the best defrosting results.

# AUTO DEFROST

## Auto Defrost Table

**NOTE:** Meat of irregular shape and large, fatty cuts of meat should have the narrow or fatty areas shielded with foil at the beginning of the defrost sequence.

### Meat Settings

FOOD	SETTING	AT BEEP	SPECIAL INSTRUCTIONS
<b>BEEF</b>			
Ground Beef, Bulk	MEAT	Remove thawed portions with fork. Turn over. Return remainder to oven.	Do not defrost less than 1/4 lb. Freeze in ball shape.
Ground Beef, Patties	MEAT	Separate and rearrange.	Do not defrost less than 2 oz. patties. Depress center when freezing.
Round Steak	MEAT	Turn over. Cover warm areas with aluminum foil.	Place in a microwave safe dish.
Tenderloin Steak	MEAT	Turn over. Cover warm areas with aluminum foil.	Place in a microwave safe dish.
Stew Beef	MEAT	Remove thawed portions with fork. Separate remainder.	Place in a microwave safe dish.
Pot Roast, Chuck Roast	MEAT	Return remainder to oven.	Place in a microwave safe dish.
Rib Roast	MEAT	Turn over. Cover warm areas with aluminum foil.	Place in a microwave safe dish.
Rolled Rump Roast	MEAT	Turn over. Cover warm areas with aluminum foil.	Place in a microwave safe dish.
<b>LAMB</b>			
Cubes for Stew	MEAT	Turn over. Cover warm areas with aluminum foil.	Place in a microwave safe dish.
Chops (1 inch thick)	MEAT	Remove thawed portions with fork. Return remainder to oven.	Place in a microwave safe dish.
<b>PORK</b>			
Chops (1/2 inch thick)	MEAT	Separate and rearrange.	Place in a microwave safe dish.
Hot Dogs	MEAT	Separate and rearrange.	Place in a microwave safe dish.
Spareribs Country-style Ribs	MEAT	Turn over. Cover warm areas with aluminum foil.	Place in a microwave safe dish.
Sausage, Links	MEAT	Separate and rearrange.	Place in a microwave safe dish.
Sausage, Bulk	MEAT	Remove thawed portions with fork. Turn over. Return remainder to oven.	Place in a microwave safe dish.
Loin Roast, Boneless	MEAT	Turn over. Cover warm areas with aluminum foil.	Place in a microwave safe dish.

# AUTO DEFROST

## Auto Defrost Table (Continued)

### Poultry Settings

FOOD	SETTING	AT BEEP	SPECIAL INSTRUCTIONS
<b>CHICKEN</b> Whole (up to 6 lbs)  Cut-up	POULTRY	Turn over breast side down. Cover warm areas with aluminum foil.  Separate pieces and rearrange.  Turn over. Cover warm areas with aluminum foil.	Place chicken breast-side up in a microwave safe dish. Finish defrosting by immersing in cold water. Remove giblets when chicken is partially defrosted.  Place in a microwave safe dish.  Finish defrosting by immersing in cold water.
<b>CORNISH HENS</b> Whole	POULTRY	Turn over. Cover warm areas with aluminum foil.	Place in a microwave safe dish. Finish defrosting by immersing in cold water.
<b>TURKEY</b> Breast (up to 6 lbs)	POULTRY	Turn over. Cover warm areas with aluminum foil.	Place in a microwave safe dish. Finish defrosting by immersing in cold water.

### Fish Settings

FOOD	SETTING	AT BEEP	SPECIAL INSTRUCTIONS
<b>FISH</b> Fillets	FISH	Turn over. Separate fillets when partially thawed, if possible.	Place in a microwave safe dish. Carefully separate fillets under cold water.
Steaks	FISH	Separate and rearrange.	Place in a microwave safe dish. Run cold water over to finish defrosting.
Whole	FISH	Turn over	Place in a microwave safe dish. Cover head and tail with foil; do not let foil touch sides of microwave. Finish defrosting by immersing in cold water.
<b>SHELLFISH</b> Crab meat	FISH	Break apart. Turn over.	Place in a microwave safe dish.
Lobster tails	FISH	Turn over and rearrange.	Place in a microwave safe dish.
Shrimp	FISH	Separate and rearrange.	Place in a microwave safe dish.
Scallops	FISH	Separate and rearrange.	Place in a microwave safe dish.

# AUTO DEFROST

## Defrosting Tips

When using Auto Defrost, the weight to be entered is the net weight in pounds and tenths of pounds (the weight of the food minus the container).

Before starting, make sure to remove any and all metal twist-ties that often come with frozen food bags, and replace them with strings or elastic bands.

Open containers, such as cartons, before placing in the oven.

Always slit or pierce plastic pouches or packaging.

If food is foil wrapped, remove foil and place food in a suitable container.

Slit the skin of skinned food, such as sausage.

Bend plastic pouches of food to ensure even defrosting.

Always underestimate defrosting time. If defrosted food is still icy in the center, return it to the microwave oven for more defrosting.

The length of defrosting time varies according to how solidly the food is frozen.

The shape of the package affects how quickly food will defrost. Shallow packages will defrost more quickly than a deep block.

As food begins to defrost, separate the pieces. Separated pieces defrost more easily.

Use small pieces of aluminum foil to shield parts of food such as chicken wings, leg tips, fish tails, or areas that start to get warm. Make sure the foil does not touch the sides, top, or bottom of the oven. The foil can damage the oven lining.

For better results, let food stand after defrosting.

Turn over food during defrosting or standing time. Break apart and remove food as required.

# CONVENIENT FEATURES

## 1. User pref

The microwave oven has settings that allow you to customize the operation for your convenience. Below is the table showing the various settings. Touch the User pref key multiple times to scroll to the desired setting function.

Key press	Option
User pref x1	Clock
User pref x2	Control Lock
User pref x3	Volume Off/ Low/Med/High/
User pref x4	Weight lb/kg
User pref x5	Clock display on/off
User pref x6	Demo

### (1). Setting Clock

The clock can be disabled when the microwave is first plugged in and the **STOP**<sub>Clear</sub> key is selected.

To re-enable the clock follow clock instructions.

- Suppose you want to set the clock for 10:59.

Touch:	Display Shows:
1. <b>USER PREF</b>	<small>PRESS AGAIN FOR OPTIONS/</small> 12:00 ENTER TIME
2. (1) (0) (5) (9)	<small>PRESS START</small> 10:59
3. <b>START</b> Enter/+30Sec	10:59

### NOTE

1. If you begin to enter in an incorrect time (e.g. 2:89) the 8 is an invalid digit and cannot be entered. Enter the correct time.
2. If you touch **STOP**<sub>Clear</sub> while setting the clock, the display will show the last time of day set or a blank display if no time of day has been set.

## (2). Setting Control Lock On/Off

To turn ON Control Lock .

Touch:	Display Shows:
1. <b>USER PREF</b>	<small>PRESS AGAIN FOR OPTIONS/</small> 12:00 ENTER TIME
2. <b>USER PREF</b>	<small>PRESS AGAIN FOR OPTIONS/ PRESS START</small> CONTROL LOCK
3. <b>START</b> Enter/+30Sec	 LOCKED

### (3).Turning Sound Low/Med/High/Off

Audible signals are available to guide you when setting and using your oven.

- **A programming tone** will sound each time you touch a pad.

- **Two tones** signal the end of a Kitchen Timer count down.

- **Two tones** signal the end of a cooking cycle.

- Suppose you want to turn audible signal off.

Touch:	Display Shows:
1. USER PREF	<small>PRESS AGAIN FOR OPTIONS/</small> 12:00 ENTER TIME
2. USER PREF	<small>PRESS AGAIN FOR OPTIONS/ PRESS START</small> CONTROL LOCK
3. USER PREF	<small>PRESS AGAIN FOR OPTIONS/ PRESS START</small> VOLUME LOW
	<small>PRESS AGAIN FOR OPTIONS/ PRESS START</small> VOLUME MED
	<small>PRESS AGAIN FOR OPTIONS/ PRESS START</small> VOLUME HIGH
4. <b>START</b> Enter/+30Sec	<small>PRESS AGAIN FOR OPTIONS/ PRESS START</small> OFF

### (4).Setting Weight Lb/Kg

- Suppose you want to toggle weight between pounds & kilograms.

Touch:	Display Shows:
1. USER PREF	<small>PRESS AGAIN FOR OPTIONS/</small> 12:00 ENTER TIME
2. USER PREF	<small>PRESS AGAIN FOR OPTIONS/ PRESS START</small> CONTROL LOCK
3. USER PREF	<small>PRESS AGAIN FOR OPTIONS/ PRESS START</small> VOLUME LOW
4. USER PREF	<small>PRESS AGAIN FOR OPTIONS/ PRESS START</small> Lb / Kg
5. <b>START</b> Enter/+30Sec	<div style="border: 1px solid red; padding: 10px; text-align: center;"> <p>Lb <sup>lb</sup></p> <p>OR</p> <p>Kg <sub>kg</sub></p> </div>

### (5).Clock Display on/off

- Suppose you want to set the clock display on.

Touch:	Display Shows:
1. USER PREF	<small>PRESS AGAIN FOR OPTIONS/</small> 12:00 ENTER TIME
2. USER PREF	<small>PRESS AGAIN FOR OPTIONS/ PRESS START</small> CONTROL LOCK
3. USER PREF	<small>PRESS AGAIN FOR OPTIONS/ PRESS START</small> VOLUME LOW
4. USER PREF	<small>PRESS AGAIN FOR OPTIONS/ PRESS START</small> Lb / Kg
5. USER PREF	<small>PRESS AGAIN FOR OPTIONS/ PRESS START</small> CLOCK DISPLAY ON
6. <b>START</b> Enter/+30Sec	OFF

### (6).Setting Demo Mode On/Of







- Suppose you want to enter Demo mode. When Demo mode is ON programming functions will work in a rapid countdown mode with no cooking power.

Touch:	Display Shows:
1. USER PREF	<small>PRESS AGAIN FOR OPTIONS/</small> 12:00 ENTER TIME
2. USER PREF	<small>PRESS AGAIN FOR OPTIONS/ PRESS START</small> CONTROL LOCK
3. USER PREF	<small>PRESS AGAIN FOR OPTIONS/ PRESS START</small> VOLUME LOW
4. USER PREF	<small>PRESS AGAIN FOR OPTIONS/ PRESS START</small> Lb / Kg
5. USER PREF	<small>PRESS AGAIN FOR OPTIONS/ PRESS START</small> CLOCK DISPLAY ON
6. USER PREF	<small>PRESS AGAIN FOR OPTIONS/ PRESS START</small> DEMO OFF OR <small>PRESS AGAIN FOR OPTIONS/ PRESS START</small> DEMO ON
7. <b>START</b> Enter/+30Sec	ON OR OFF

## 2. Setting Kitchen Timer

Your microwave oven can be used as a kitchen timer. You can set up to 99 minutes, 99 seconds. The kitchen timer can be used while the microwave oven is running.



- Suppose you want to set for three minutes.

Touch:	Display Shows:
1. TIMER	
2.   	
3. 	 Timer starts counting down

## 3.Using Vent Fan

The pad controls the 2-speed vent fan. If the vent fan is OFF, the first touch of the Vent pad will turn the fan on HIGH, second touch LOW and third touch OFF.

- Suppose you want to set the vent fan speed to LOW from the OFF position.

Touch:	Display Shows:
1. 	HIGH
2. 	LOW

## CONVENIENT FEATURES

### NOTE

If the temperature from the range or cooktop below the oven gets too hot, the vent fan will automatically turn on to protect the oven. It may stay on up to an hour to cool the oven. When this occurs, the Vent pad will not turn the fan off.

## 4.Using Cooktop Light

The pad controls the cooktop light. If the light is OFF the first touch of the light pad will turn the light ON (high), second touch (low) and third touch OFF.

- Suppose you want to set the light for HIGH from the OFF position.

Touch:	Display Shows:
1. 	HIGH

## 5. Setting Turntable On/Off

Press **Turntable On-Off** to turn the turntable on or off.

For best cooking results, leave the turntable on. It can be turned off for large dishes.

Touch:	Display Shows:
1. TURNTABLE on-off	OFF
2. TURNTABLE on-off	ON

### NOTE

Sometimes the turntable can become hot to the touch during and after cooking. Do not run the oven empty without food in it.

# MAINTENANCE

## Troubleshooting

Check your problem by using the chart below and try the solutions for each problem. If the microwave oven still does not work properly, contact the nearest authorized service center.

TROUBLE	POSSIBLE CAUSE	POSSIBLE REMEDY
Oven will not start	<ul style="list-style-type: none"> <li>a. Electrical cord for oven is not plugged in.</li> <li>b. Door is open.</li> <li>c. Wrong operation is set.</li> </ul>	<ul style="list-style-type: none"> <li>a. Plug into the outlet.</li> <li>b. Close the door and try again.</li> <li>c. Check instructions.</li> </ul>
Arcing or sparking	<ul style="list-style-type: none"> <li>a. Materials to be avoided in microwave oven were used.</li> <li>b. The oven is operated when empty.</li> <li>c. Spilled food remains in the cavity.</li> </ul>	<ul style="list-style-type: none"> <li>a. Use microwave-safe cookware only.</li> <li>b. Do not operate with oven empty.</li> <li>c. Clean cavity with wet towel.</li> </ul>
Unevenly cooked foods	<ul style="list-style-type: none"> <li>a. Materials to be avoided in microwave oven were used.</li> <li>b. Food is not defrosted completely.</li> <li>c. Cooking time, power level is not suitable.</li> <li>d. Food is not turned or stirred.</li> </ul>	<ul style="list-style-type: none"> <li>a. Use microwave-safe cookware only.</li> <li>b. Completely defrost food.</li> <li>c. Use correct cooking time, power level.</li> <li>d. Turn or stir food.</li> </ul>
Overcooked foods	Cooking time, power level is not suitable.	Use correct cooking time, power level.
Undercooked foods	<ul style="list-style-type: none"> <li>a. Materials to be avoided in microwave oven were used.</li> <li>b. Food is not defrosted completely.</li> <li>c. Oven ventilation ports are restricted.</li> <li>d. Cooking time, power level is not suitable.</li> </ul>	<ul style="list-style-type: none"> <li>a. Use microwave-safe cookware only.</li> <li>b. Completely defrost food.</li> <li>c. Check to see that oven ventilation ports are not restricted.</li> <li>d. Use correct cooking time, power level.</li> </ul>
Improper defrosting	<ul style="list-style-type: none"> <li>a. Materials to be avoided in microwave oven were used.</li> <li>b. Cooking time, power level is not suitable.</li> <li>c. Food is not turned or stirred.</li> </ul>	<ul style="list-style-type: none"> <li>a. Use microwave-safe cookware only.</li> <li>b. Use correct cooking time, power level.</li> <li>c. Turn or stir food.</li> </ul>

# Warranty

---

## LIMITED WARRANTY

---

LIMITED WARRANTY KOOLMORE SUPPLY, INC. warrants to the original consumer or purchaser this KOOLMORE product is free from defects in material or workmanship for a period of One (1) year from the date of purchase. If any such defect is discovered within the warranty period, KOOLMORE SUPPLY, INC., at its discretion, will repair or replace the product at no cost or pay for replacement parts and repair labor to correct defects in materials or workmanship that existed when this major appliance was purchased or that are the result of normal usage when this major appliance is installed, operated and maintained according to instructions attached to or furnished with the product, At its sole discretion. Koolmore Supply Inc may determine to replace the product. In the event of product replacement, your appliance will be warranted for the remaining term of the original unit's warranty period.

This limited warranty is good only to the original purchaser of the product and effective only when used in the United States.

This limited warranty is effective from the date of original consumer purchase. Proof of original purchase date is required to obtain service under this limited warranty.

YOU'RE SOLE AND EXCLUSIVE REMEDY UNDER THIS LIMITED WARRANTY SHALL BE PRODUCT REPAIR AS PROVIDED HEREIN.

Service must be provided by a Koolmore designated service company.

For warranty or repair service: Email us at [support@koolmore.com](mailto:support@koolmore.com) include your name, address, phone number, warranty repair request, and a copy of your proof of purchase receipt.

You can also visit us at [koolmore.com](http://koolmore.com) and use the contact us page.

KOOLMORE customer service will contact you and arrange prompt service for your appliance.

Product registration is not mandatory. Failure to complete and return the card or form does not diminish the consumer's warranty rights.

Thank you for choosing KOOLMORE.

## THIS LIMITED WARRANTY DOES NOT APPLY TO

---

- 1.Failure of product to perform during power failures and interruptions or inadequate electrical service
- 2.Damage caused by transportation or handling.
- 3.Damage caused to the product by accident, vermin, lightning winds, fire, floods, or acts of God.
- 4.Damage resulting from accident, alteration, misuse, abuse, or improper installation, repair, or maintenance. Improper use includes using an external device that alters or converts the voltage or frequency of electricity
- 5.Any unauthorized product modification, repair by unauthorized repair center, or use of non-approved replacement parts.
- 6.Abnormal cleaning and maintenance as described in the user's manual.
- 7.Use of accessories or components that are not compatible with this product.

The cost of repair or replacement under these excluded circumstances shall be borne by the consumer.

### For Warranty Inquiries or Service:

This warranty is only valid on equipment purchased from an authorized dealer.

1. Locate the model number.
2. Next, call 1-718-576-6342. You must have the model number when contacting service technicians.

Failure to contact Koolmore prior to obtaining equipment service may void your warrant