



# USER MANUAL

## PHARMACY REFRIGERATOR

### Pharmacy Refrigerator

Models:

KM-PHR-11C

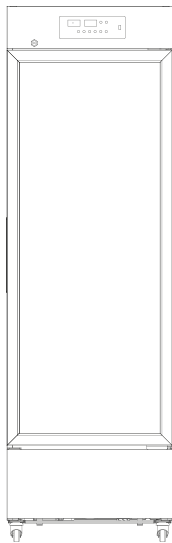

KM-PHR-15C

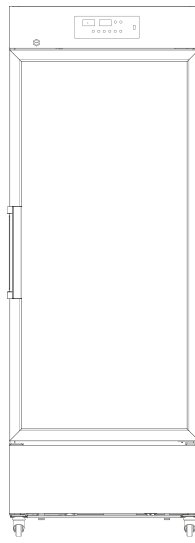

KM-PHR-27C

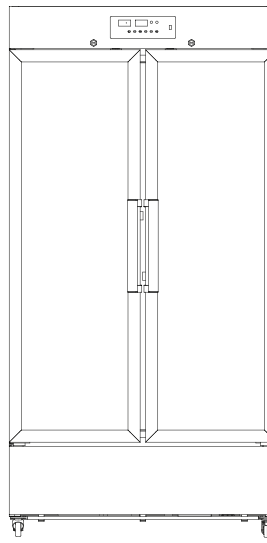

KM-PHR-35C

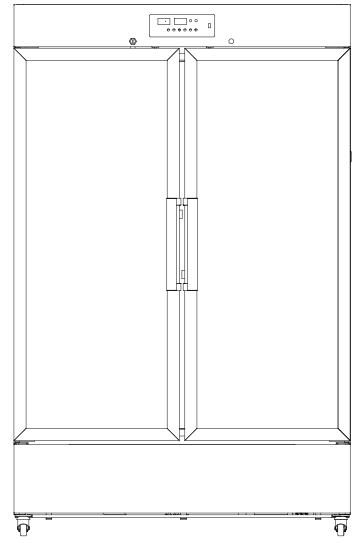

***Before using, please read the operating instructions carefully to ensure proper application and achieve satisfactory results.***

For any service-related issues, please contact us:



718-576-6342



support@koolmore.com

706 Eastern Parkway STE 1G Brooklyn NY 11213

***Stay informed with the latest information  
for your KoolMore Appliance.***

**If you need any assistance or have questions, our customer  
support team is here to help.**

 718-576-6342  [support@koolmore.com](mailto:support@koolmore.com)

# Contents

I. SAFETY .....	5
II. PRODUCT FEATURES .....	6
III. PRODUCT INSTALLATION .....	7
IV. START-UP .....	10
V. OPERATING INSTRUCTIONS .....	12
VI. MAINTENANCE .....	19
VII. TROUBLESHOOTING .....	21
WARRANTY .....	22



**DANGER:** This appliance uses a flammable refrigerant, which poses a risk of fire or explosion. Do not use mechanical devices to defrost the refrigerator, and do not puncture the refrigerant tubing.

**DANGER:** Only trained service personnel should repair this appliance, as it uses a flammable refrigerant. Do not puncture the refrigerant tubing.

**CAUTION:** This appliance uses a flammable refrigerant. Before attempting to service the product, consult the repair manual or owner's guide and follow all safety precautions.

**CAUTION:** Dispose of this appliance properly in accordance with federal or local regulations, as it uses a flammable refrigerant.

**CAUTION:** There is a risk of fire or explosion if the refrigerant tubing is punctured. Handle the appliance carefully and follow all handling instructions. This appliance uses a flammable refrigerant.

**CAUTION:** Keep all ventilation openings in the appliance enclosure or in the structure for building-in clear of obstructions.

**CAUTION:** Only factory authorized service personnel should service this appliance to minimize the risk of ignition due to incorrect parts or improper service.

# I. SAFETY

Dear KoolMore users:

We appreciate your choice of the KoolMore medical cooler. We urge you to go through the subsequent details for a comprehensive grasp of the User Manual, which will aid in safe utilization of this device and minimize risks to both individuals and objects.

This equipment is intended for use in commercial, industrial, or institutional occupancies as defined in the Safety Standard for Refrigeration Systems, ANSI/ASHRAE 15`.



**Warning: Risk of fire/flammable materials**

**WARNING: Ensure all ventilation openings are not obstructed.**

**WARNING: Do not use mechanical devices or other means to accelerate the defrosting process, other than those recommended by the manufacturer.**

**WARNING: Do not damage the refrigerant circuit**

**WARNING: In order to reduce flammability HAZARDS the installation of this equipment shall only be carried out by a suitably qualified person.**

**DANGER – Risk Of Fire Or Explosion. Flammable Refrigerant Used. To Be Repaired Only By Trained Service Personnel. Do Not Puncture Refrigerant Tubing.**

**CAUTION – Risk Of Fire Or Explosion. Flammable Refrigerant Used. Consult Repair Manual / Owner's Guide Before Attempting To Install Or Service This Equipment. All Safety Precautions Must Be Followed.**

**CAUTION – Risk Of Fire Or Explosion. Dispose Of Properly In Accordance With Federal Or Local Regulations. Flammable Refrigerant Used.**

**CAUTION – Risk Of Fire Or Explosion Due To Puncture Of REFRIGERANT Tubing. Follow Handling Instructions Carefully. FLAMMABLE REFRIGERANT Used**

**The installation and operating instructions shall indicate that component parts shall be replaced with like components and that servicing shall be done by the manufacturer's authorised personnel, so as to minimize the risk of possible ignition due to incorrect parts or improper service.**

REFRIGERANT and BLOW gas used for the appliance are flammable. Therefore, when the appliance is scrapped, it shall be kept away from any fire source and be recovered by a special recovering company without corroding qualification other than be disposed by combustion, so as to prevent damage to the environment or any other harm.

## II. Product Features

Category	Description
<b>Product Features</b>	Can store medicines, vaccines, reagents, and materials between 2°-8°C.
<b>Accurate Temperature Control</b>	<ul style="list-style-type: none"> <li>- Displays an accuracy of 0.1°C.</li> <li>- Ranges from 2°C to 8°C with in-box fluctuations of ±2°C.</li> <li>- USB interface allows temperature data storage at any time.</li> </ul>
<b>Efficient Refrigeration</b>	<ul style="list-style-type: none"> <li>- High-efficiency fans for lasting performance and low noise.</li> <li>- Maintains a uniform temperature and efficient cooling.</li> <li>- Uses embedded air duct and air curtain technologies.</li> </ul>
<b>Safety Features</b>	<ul style="list-style-type: none"> <li>- Alarms for high and low temperature, power failure, and sensor issues.</li> <li>- Customizable alarm temperatures.</li> <li>- Safety door lock for sample protection.</li> </ul>
<b>User-Friendly Design</b>	<ul style="list-style-type: none"> <li>- Multi-layer encryption shelves and adjustable heights.</li> <li>- Energy-saving inner LED lights.</li> <li>- Operates within a 115V±10% voltage range.</li> </ul>

# III. Product Installation

## Product Handling:

- When transporting the pharmacy refrigerator, ensure it is moved with care, using the handcart method shown in the accompanying image, cushioning the unit appropriately.
- Upon arrival at the desired location, remove all packing materials and the bottom cushion.
- Relocate the refrigerator to its final placement within the house or facility.
- Once positioned, allow the unit to sit undisturbed for about 2 hours before turning the power on. This allows it to acclimate to its new environment.

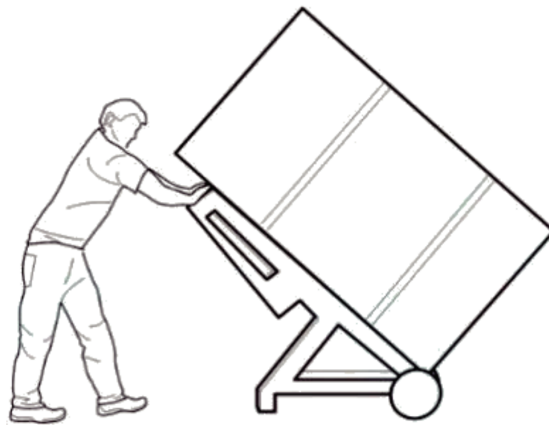

## Installation Environment:

- The pharmacy refrigerator is designed exclusively for indoor usage. Ensure it is situated in an area with no more than a pollution level of Class 2 and safeguard against over-voltage of Class II.
- The ambient temperature where the refrigerator is placed should range between 60.8°F-89.6°F, with an ideal temperature span of 64.4°F-77°F. If this temperature range is not naturally achieved, consider utilizing an air conditioning system.
- Maintain an environmental humidity level below 80% relative humidity (RH) to ensure optimal performance.
- To prevent disturbances, situate the refrigerator away from areas prone to significant dust or mechanical vibrations.
- When deciding on placement, be mindful that the refrigerator's altitude doesn't exceed 6561 feet above sea level.
- Ensure the working voltage remains within a 10% deviation of the designated requirement.
- The pharmacy refrigerator comes with an ingress protection rating of IPX0, which indicates a lack of protection against water or dust ingress.
- This appliance is sensitive to ambient temperature variations. If installing in regions other than those recommended, the refrigerator might not function optimally. Adjust the environment as needed.
- Always place the pharmacy refrigerator in a dry environment. Exposure to moisture or wet conditions can result in electric leakage or potential electric shock hazards.

## Installation Site

- It's crucial not to place the device in cramped or confined spaces. Choose a location that ensures easy access and minimizes the chance of goods blocking airflow or causing storage issues.
- The installation location should be stable and free from flammable materials, ensuring the appliance remains upright during operation and minimizing hazards.
- It's important to shield the device from direct sunlight as this could impact its performance.
- Ensure that each refrigerator has its own dedicated power outlet. Verify that the power connection uses a standard 110V outlet and that both the plug and socket are securely connected.
- Before operating the device, check the provided working voltage. In areas where voltage might fluctuate, consider investing in a voltage stabilizer. If you decide to use one, its power capacity should be greater than 400W, ensuring that the device's voltage needs are adequately met.
- Grounding the device is crucial for safety. If your power outlet isn't equipped with a ground, or if you're unsure about its effectiveness, enlist the services of professional engineers or technicians to ensure proper grounding.

## Warnings:

For safety reasons, never attempt to ground the refrigerator using unconventional methods like gas pipes, water pipes, telephone lines, or lightning rods. These methods could introduce the risk of electrical shock.

Once installed, ensure the power plug remains easily accessible. This design allows for quick disconnection in emergencies. Additionally, avoid placing objects near the refrigerator's vent to ensure unobstructed airflow.

Alarm port: 30Vdc, 2A Max, to be connected to SELV circuit.

USB port: 5Vdc, 1A Max, to be connected to SELV circuit.

## Notes:

Ambient temperature plays a significant role in the performance of the device. If the surrounding temperature is outside the range of 104°F-140°F, the refrigerator may not function as expected. It's important to note that the device uses an intermittent operating mechanism. Before use, adjust the environment accordingly.

For storage and transportation purposes, it's advisable to maintain temperatures within the 104°F-140°F range and a relative humidity of 10%-90%.

## Preparation Before Use

1. Begin by removing all the external packaging materials, including the protective foam inside the box, to access the product.

2. Ensure all accessories are present. Inspect the box's contents, and if there are any discrepancies or missing items, get in touch with the after-sales service department promptly.

3. When deciding on placement for the pharmacy refrigerator, it's crucial to allow a buffer of at least 4 inches around it. This space facilitates adequate ventilation and helps dissipate heat efficiently.

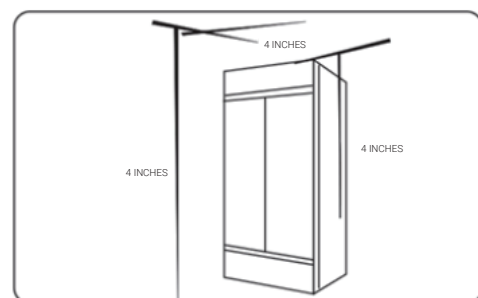

4. The refrigerator comes with front casters for mobility. Additionally, there are adjustable feet

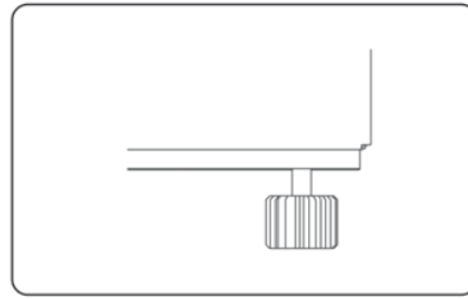
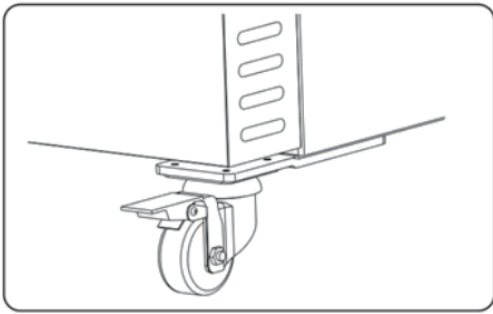

(which are optional). To stabilize the unit, rotate these feet clockwise. This downward extension ensures that the refrigerator remains steady and well-grounded during daily operations.

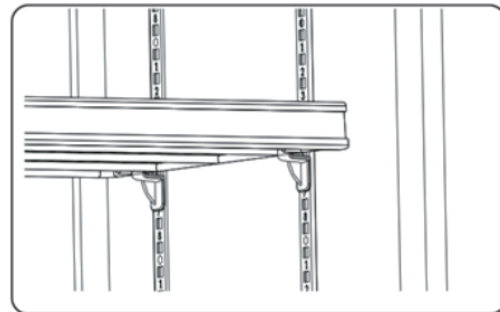
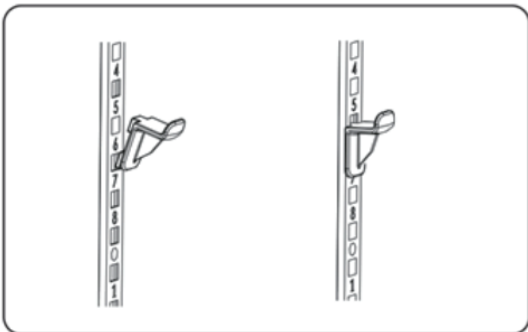

5. Depending on your storage requirements, you can adjust the internal spacing. Install or move

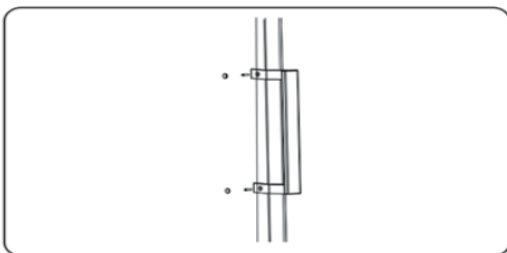

the shelves to best fit your items.

6. The unit may come with an optional door handle. If yours does, proceed with its installation.

7. At the rear of the pharmacy refrigerator, you'll find a back bracket. Securely attach this bracket to the refrigerator's back plate using the provided screws.

**Warning:**

Safety first: Be cautious with the appliance's plastic bags. Always place them out of children's reach to prevent the risk of suffocation accidents.



## IV. Start-up

### Initial Start-up Instructions

When setting up the appliance for the first time, follow these guidelines:

1. In a no-load condition, make sure to plug into the correct power outlet, ensuring that it doesn't interfere with other connected appliances.
2. Switch on the device, and then promptly activate its battery switch.
3. The LED light will indicate the unit's power status. For detailed insights on power status, consult the unit's data recording settings.
4. You can set the desired temperature intervals. By default, the temperature is set at 41°F. The upper limit is 46.4°F, while the lower limit is 35.6°F. Check the user manual for specifics.
5. An alert labeled "H1" signifies an elevated temperature. This alarm ceases once the internal temperature falls back within the safe range.
6. If you see a "L0" alert, it indicates the data recorder isn't operational. Please refer to the user manual for troubleshooting.
7. A "L1" alert during the initial setup signifies low battery. The alarm will stop after 2-6 hours once the battery regains its charge.
8. Ensure the equipment runs uninterrupted for at least 3 hours during the initial start-up.

### Post-Power Outage Operations

If there's a power interruption, the appliance will revert to its last known settings once power is restored.

### Warning:

- If you switch off the refrigerator, wait for more than five minutes before restarting. An immediate restart might harm the compressor or the system.
- For prolonged inactivity, it's recommended to disconnect the power and battery to avoid electrical hazards.
- Always ensure that children don't have access to the refrigerator, especially when its door isn't fully closed.
- A designated individual should oversee this product's operation, ensuring that the temperature is checked and recorded daily. If the temperature inside the cabinet deviates too far from the ideal, either being too hot or too cold, then items should be relocated to another safe storage until the root of the problem is resolved.
- The recommended temperature range for this pharmacy refrigerator is between 35.6°F and 46.4°F. It's essential to ensure that this range aligns with the ambient conditions in the pharmacy to prevent potential damages and economic losses.
- Please note that the display temperature and the actual temperature inside the product can vary. Such variation is normal, and it doesn't imply a malfunction.
- Avoid placing items in the narrow space that exists between the pharmacy refrigerator's bottom shelf and its floor to ensure proper air circulation.

- Given that the pharmacy refrigerators are designed for preservation, it's crucial not to overload them. Overfilling can strain the compressor, leading to temperature fluctuations that, over time, can reduce the compressor's lifespan. If the temperature starts to rise, it's essential to progressively and methodically reduce the load inside until conditions stabilize.
- The device's refrigeration circuitry is vital and should be protected from damage.
- For safety reasons, the use of non-certified electrical devices inside the pharmacy refrigerator is strictly prohibited.

## Product composition and overview

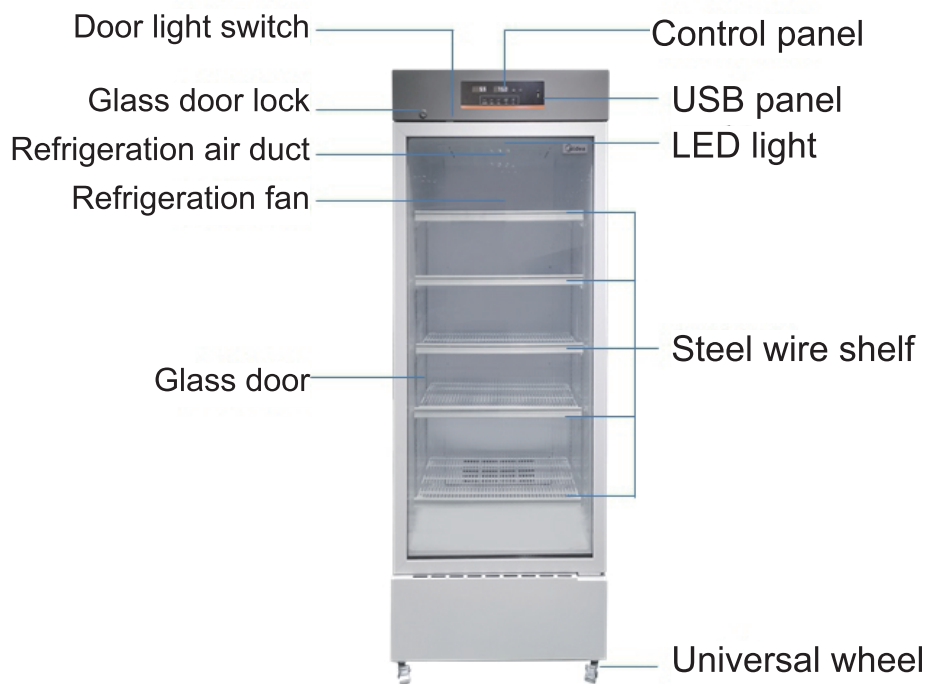

Due to the improvement of products and different models, the actual products may be different from the schematic drawings. Please refer to the real objects! The sketch is only used for the description of the functional parts.

# V. Operating instructions

## Operation and display panel

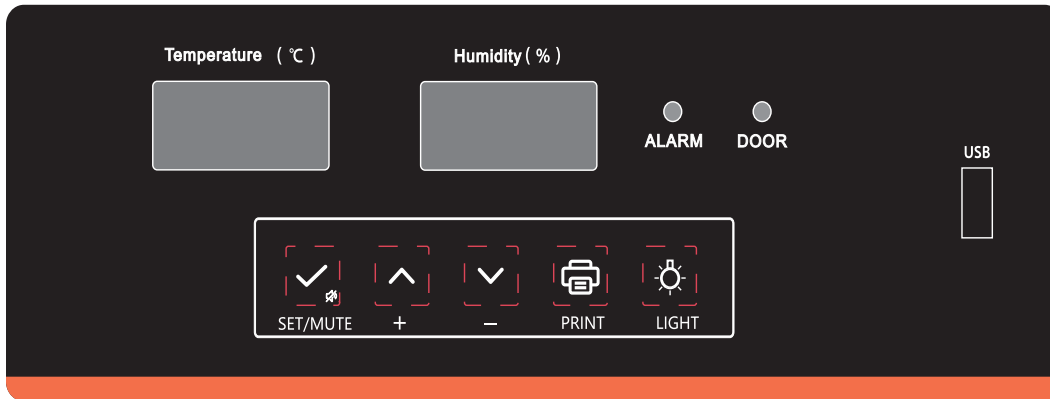

### Digital tube display instructions:

- The right digital tube displays only humidity and maintains a consistent humidity readout.
- The left digital tube shows temperature, alarm codes, menu, parameters, and additional details.
- References to the "digital tube" in "key operation" pertain to the left digital tube.

### Indicators

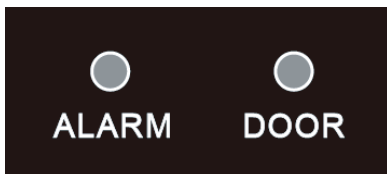

Indicator status	Alarms
Alarm light off	Temperature in the box is normal.
Alarm light on	Temperature in the box is abnormal.
Door light off	The door is closed.
Door light on	The door is open.

# Key Operation:

## Key Lock Function:

A) The key automatically locks if there's no activity for 60 seconds or if both the Up and Down keys are held for 3 seconds simultaneously.





B) With a locked key, users can only view the ambient temperature. Only the Mute and Light switches are operable; all other keys remain locked.

### C) Steps to Unlock Key:

1. Press and hold both Up and Down keys for 3 seconds when locked. The display will show "000".
2. Use the Up and Down keys to enter the password (default is 005).
3. Confirm the unlock action by pressing the Set/Mute key. The display returns to its regular view, and the key lock deactivates.

## Key functions

### Key names

Key symbols	Key names
	Set/Mute key
	Up key
	Down key
	Print key
	Light switch

## User Parameter Setting:

To adjust user-specific parameters, follow these steps (more details can be found in the user menu parameter table):

1. Ensure the key is unlocked. Hold the Set/Mute key for 3 seconds. The display will then show "PS1".
2. Use the Up or Down keys to select the parameter you want to adjust.
3. Press the Set/Mute key to enter the parameter modification mode.
4. Use the Up or Down keys again to set the desired value for the parameter.
5. If there's no activity for 60 seconds or if the Set/Mute key is pressed for 3 seconds, the new parameter value will be saved, and the system will exit the settings mode.

Door electrical heating mode setting example(set door electrical heating mode from 2 to 4)

Steps	Operation	Display shows
1	Press key to unlock(refer to previous instruction)	
2	Press Set/Mute key 3s	PS1
3	Press Up key, Down key to choose settable parameter"P1"	P1
4	Press Set/Mute key	002
5	Press Up key, Down key to change parameter to 4	004
6	Press Set/Mute key 3s to save parameter and quit	

Temperature setting example(set temperature from 5 to 3)

Steps	Operation	Display shows
1	Press key to unlock(refer to previous instruction)	
2	Press Set/Mute key 3s	PS1
3	Press Up key,Down key to choose settable parameter"SET"	SET
4	Press Set/Mute key	005
5	Press Up key, Down key to change parameter to 3	003
6	Press Set/Mute key 3s to save parameter and quit	

### Key unlocked password setting example(set password from 5 to 7)

Steps	Operation	Display shows
1	Press key to unlock(refer to previous instruction)	
2	Press Set/Mute key 3s	PS1
3	Press Up key, Down key to choose settable parameter"PS1"	PS1
4	Press Set/Mute key	005
5	Press Up key, Down key to change parameter to 7	007
6	Press Set/Mute key 3s to save parameter and quit	

### Starting the Recorder:

If the key is unlocked and the recorder hasn't started, the digital display will flash an "LoF" alarm. To clear the alarm, press the Set/Mute and Up keys simultaneously for 3 seconds. The display will then stop showing "LoF".

### Setting the Recorder Time:

After a power outage, once the pharmacy refrigerator is powered on again, the display will sequentially show numbers: 1, 2, 3... up to n.

Users can adjust parameters corresponding to each number (as detailed in a subsequent table) when a specific number (n) is shown on the display.

n	Year
y	Month
r	Date
s	Hour
F	Minute
Pt	Printing interval
SCY	Data recording interval

### "Year" setting example(set year to 2022)

Steps	Operation	Display shows
1	Display shows n	n
2	Press Set/Mute key	0
3	Press Up key, Down key to change parameter to targeted year	22
4	Press Set/Mute key	
5	Press Set/Mute key 3s to save parameter and quit	

Steps	Operation	Display shows
1	When the display shows "n"	n
2	Use the up or down key to select "y" (desired parameter)	y
3	Press the set/mute key	0
4	Use the up or down key to adjust to the desired month value	
5	Confirm by pressing the Set/Mute key for 3 seconds	

### Month Setting Example

(Other settings such as r, F, Pt, SCY also follow this example)

Note: Please finish setting in 2 minutes. If no operation is done within that time, the system will automatically revert to its normal display. Before changing the recorder time and data recording interval, ensure that the previous data is exported; otherwise, data might be lost.

### Manually Generating PDF Files

If the key is unlocked and no file is being generated:

- Connect a USB flash disk.
- Press the Up key for 3s until "d01" is shown.
- Adjust with Up or Down key from "d00-d12".
- Confirm with Set/Mute key. This action generates PDF files for past months where data is recorded.
- When operating under standard voltage, press the Light switch to toggle light on or off.

### Alarm Instructions

#### A) General Alarm:

When it beeps, press Set/Mute to silence.

If turned on, it signals the start of an ambient temperature check.

If turned off, it'll recheck the ambient temperature.

#### B) Temperature Alarm:

Press Set/Mute to silence and check ambient temperature.

If no key operation for 10 minutes, the alarm will sound again.

#### C) Checking Ambient Temperature:

When the key is locked, press Set/Mute to display ambient temperature. It will revert to normal

display after no key operation for 5s.

If the key is unlocked, the same operation will display the temperature and return to the default view after 5s of inactivity.

## **Recording Temperature**

The device records data every 10 minutes.

## **Exporting to USB Data**

### **1. Instant Data Upload:**

On connecting a USB flash drive, the device alerts with a beep and the display shows the "on" code, indicating data transfer.

The system creates PDF files for both the current and the previous month.

Once the transfer completes, an "End" alert displays for 6 seconds before returning to its normal display.

If data quantity is smaller, the "on" and "end" codes might not display.

### **2. Monthly Data Upload:**

If the USB drive remains connected, data from the current month is transferred to the PDF every alternate month.

A beep and the "on" display indicate the beginning of the transfer, especially for larger datasets.

Post transfer, an "End" alert appears briefly before the display returns to its normal state.

### **3. Manual Data Generation:**

In instances where a USB drive connects but no automatic file generation occurs, PDFs for the current month and the preceding 12 months can be created manually.

**Note:** Device features may vary. For specific configurations, refer to the accompanying manual.

## Alarms

Serial number	Alarm code	Alarms	Alarm reason
1	H1	Alarm for high temperature in the cabinet	Interior temperature >SEt+H
2	L1	Alarm for low temperature in the cabinet	Interior temperature <SEt-L
3	H2	High ambient temperature alarm	Ambient temperature >tH1
4	do	Door open alarm	Door ajar time over 1 minute
5	PF	Low voltage alarm	Low battery voltage
6	EP	High voltage alarm	High battery voltage
7	BL	Low battery alarm	Low battery
8	Eb	Abnormal battery alarm	Battery abnormal
9	E1	Alarm for control sensor failure	Sensor error
10	E2	Alarm for upper temperature sensor failure	Display sensor error
11	E4	Alarm for ambient temperature sensor failure	Ambient temperature sensor error
12	E5	Alarm for evaporator temperature sensor failure	Defrostation sensor error
13	E7	Alarm for humidity sensor failure	Humidity sensor error
14	EE	Alarm for communication failure of display panel	Display communication failure
15	Er	Alarm for communication failure of recorder	Recorder communication failure

Note: If the alarm remains active and does not cease, please reach out to customer service for assistance.

Note: It's important to recognize that the functional features of the product might differ based on the specific model or version. Always refer to the exact specifications and features provided with your purchased product.



## User menu parameter list

Menu level	Menu	Menu description	Setting range	Default	Unit
<b>User menu</b>					
Optional	MAX	Maximum temperature in the current time period	---	---	°F
Optional	MIN	Minimum temperature in the current time period	---	---	°F
SET	CLR	Clear the record of maximum and minimum temperature in the current time period.	0: clear	1: not clear	
SET	H	Upper deviation on high temperature alarm	32.0-212.0	41	°F
SET	L	Lower deviation on low temperature alarm	32.0-212.0	37.4	°F
SET	n	Check the current date - year	---	---	year
SET	y	Check the current date - month	---	---	month
SET	r	Check the current date - day	---	---	day
SET	S	Check the current date - hour	---	---	hour
SET	F	Check the current date - minute	---	---	minute
Optional	Pt	Printing interval	0-240	20	min
Optional	th1	Ambient temperature alarm value	68.0-122.0	104	°F
Optional	P1	Door heating mode selection			
		1: automatic heating mode 1		1	
		2: automatic heating mode 2			
		3: automatic heating mode 3			
		4: the door keeps open			
		5: the door keeps closed			
Optional	P2	Display mode selection			
		1: average temperature		1	
		2: upper temperature			
		3: lower temperature			
	PS1	Password setting of user menu	000-999	005	

### Glass door electrical heating mode instruction:

#### Select 1 for glass door electrical heating mode P1:

- Heating for 3 minutes after the door is opened and closed.
- If the door is reopened and reclosed during the heating procedure, the heating timer will restart.

#### Select 2 for glass door electrical heating mode P1:

- Electrical heating activates while the compressor is in operation.
- Electrical heating turns off 1 minute after the compressor shuts down.

### **Select 3 for glass door electrical heating mode P1:**

- Electrical heating activates when the interior humidity exceeds 80%.
- However, if the interior humidity drops below 60%, the electrical heating remains on, unless there's a sensor error or shield.

### **Select 4 for glass door electrical heating mode P1:**

- Electrical heating remains on.

### **Select 5 for glass door electrical heating mode P1:**

- Electrical heating remains off.

## **VI. Maintenance**

### **Warning**

- Always disconnect the power before conducting any repairs or maintenance to ensure safety against electrical shock or potential injuries.
- Be cautious about inhaling any medications or suspended particles nearby to avoid health risks.

### **Note**

- Avoid sprinkling water directly on the unit, as this could affect the electrical components and induce rust.
- Abstain from using hot water, harsh detergents, or organic solvents when cleaning the cabinet.
- Do not place heavy items atop the device, which may cause it to deform or undergo undue pressure.

### **Device Maintenance**

**Defrosting:** The device features automatic defrosting for user convenience.

### **Cleaning:**

- For optimal performance, cleanse the pharmacy refrigerator monthly.
- A damp cloth can be used to wipe minor external and internal dirt. If the refrigerator has significant dirt, use a cloth soaked in a neutral detergent. Always ensure to rinse and then dry with a clean cloth.
- Avoid storing items on or inside the refrigerator that could potentially harm the device or disrupt its electrical insulation.
- The compressor and related mechanical components are sealed, eliminating the need for

lubrication.

### **Device Deactivation**

- When storing the device in an unsupervised area for extended periods:
- Ensure it's off and unplugged.
- Clean both the interior and exterior using a warm, damp cloth followed by drying.
- Always lock the device to ensure child safety and prevent any unintentional access, reducing risks like suffocation.

### **End-of-Life Instructions**

Once the device approaches its lifespans conclusion:

- It should be decommissioned and entrusted to certified recycling entities for appropriate scrapping and disposal, in line with local guidelines and regulations.
- It's crucial that individuals without proper credentials refrain from taking apart or tampering with the device unauthorizedly.
- Any discarded device should be allocated to specified zones, ensuring they remain out of children's reach to prevent potential hazards.

## VII. Troubleshooting

Malfunction	Troubleshooting
Refrigerator does not work	- Check if the input power conforms to specifications.
	- Verify the plug and socket connections are secure.
	- Inspect for any issues in the input and control lines.
	- Determine if the voltage is too low.
	- Ensure the fridge isn't overcrowded with hot items.
The cooling effect is unsatisfactory	- Ensure items inside are spaced out evenly.
	- Keep the fridge away from direct sunlight or heat sources.
	- Limit the frequency of opening the door.
	- Verify if the surrounding temperature is unusually high.
	- Ensure smooth air circulation without obstructions.
	- Check if the fridge sits level and stable.
	- Ensure the cabinet doesn't touch any external objects or walls.
Excessive noise	- A slight noise variation can be due to ambient noise, open doors, or the compressor.
The alarm keeps beeping	- Items recently added can cause a temporary rise in temperature. The alarm should stop after a short while.
	- Make sure the door is properly closed.
	- Check the battery status. Normal operation should resume after some time.
	- Verify that the temperature inside the fridge is within the acceptable range.



# WARRANTY

## LIMITED WARRANTY

---

Koolmore Supply, Inc. extends a limited warranty to the original purchaser, guaranteeing that this Koolmore product is free from manufacturing defects in material or workmanship for one year from the date of purchase.

Should you discover any such defect within the warranty period, Koolmore Supply, Inc., reserves the right to repair or replace the product without charge, or to cover the cost of replacement parts and repair labor needed to correct defects present at the time of purchase or resulting from regular usage, when the appliance has been installed, operated, and maintained as per the instructions provided.

At its sole discretion, Koolmore Supply Inc. may decide to replace the product. In such an event, your replacement appliance will carry the warranty for the remaining term of the original unit's warranty period.

This warranty is valid exclusively to the original purchaser of the product and only applicable within the United States. The warranty commences from the date of original consumer purchase. Proof of the original purchase date will be required to obtain service under this warranty.

Under this limited warranty, your sole and exclusive remedy will be product repair, as outlined above. All services must be provided by a Koolmore-designated service company.

To claim warranty or request repair service:

Email [support@koolmore.com](mailto:support@koolmore.com). Please include your name, address, phone number, warranty repair request, and a copy of your proof of purchase receipt. Alternatively, visit [koolmore.com](http://koolmore.com) and use the contact us page. A Koolmore customer service representative will promptly arrange service for your appliance.

We thank you for choosing Koolmore.

## WARRANTY EXCLUSIONS

---

This limited warranty will not cover:

1. Failure of the product to perform during power failures or interruptions, or due to inadequate electrical service.
2. Damage incurred during transportation or handling.
3. Damage caused by accidents, vermin, lightning, winds, fire, floods, or acts of God.
4. Damage resulting from accidents, alterations, misuse, abuse, improper installation, repair, or maintenance. This includes using any external device that alters or converts the voltage or frequency of electricity.
5. Unauthorized product modifications, repairs by unauthorized centers, or use of non-approved replacement parts.
6. Abnormal cleaning and maintenance not aligned with the user's manual.
7. Use of incompatible accessories or components.
8. Any costs associated with repairs or replacements under these excluded circumstances shall be the responsibility of the consumer.

