



SPEC SHEET

KoolMore 71 in. Display Ice Cream Freezer - 20 cu ft.

SKU: MCF-20C

FEATURES

- Premium Ice Cream Freezer.
- Large Capacity Storage Space.
- Bright LED Lighting with Clear Top.
- Space-Saving Freezer Baskets
- ETL Listed for Safety and Sanitation.



CLOSE UP IMAGES



TECHNICAL SPECS

Dimensions

Length	70.8
Width	28.1
Height	34.5
Interior Depth	21.2
Interior Width	65.1
Interior Height	24.1
Power Cord Length	70.8

Weight & Capacity

Weight Lbs	177
Gross Cubic Feet	19.7
Net Cubic Feet	14.5
Number of Freezer Baskets Bins	6
Minimum Side Air Clearance In	4 in.
Minimum Back Air Clearance In	4 in.

Features & Materials

Defrost Type	Manual
Refrigerant Type	R-290
Temperature Range	-15-32 F
Ambient Temperature Range	0-100 F
Interior Material	Steel
Exterior Material	Durable white powder coated steel
Casters	6
Noise	55 db
Door Style	Sliding
Number of Doors	2
Color Finish	White
Individual Bin Capacity	50 Lbs

Electric & Certifications

Interior Lights	LED
Voltage	110
Amps	4
Hertz	60
Phase	1
Wattage	372
Plug Type	NEMA 5-15P
Certifications	ETL Listed for Safety and Sanitation
	DOE Compliant
	ADA Compliant

Plan View

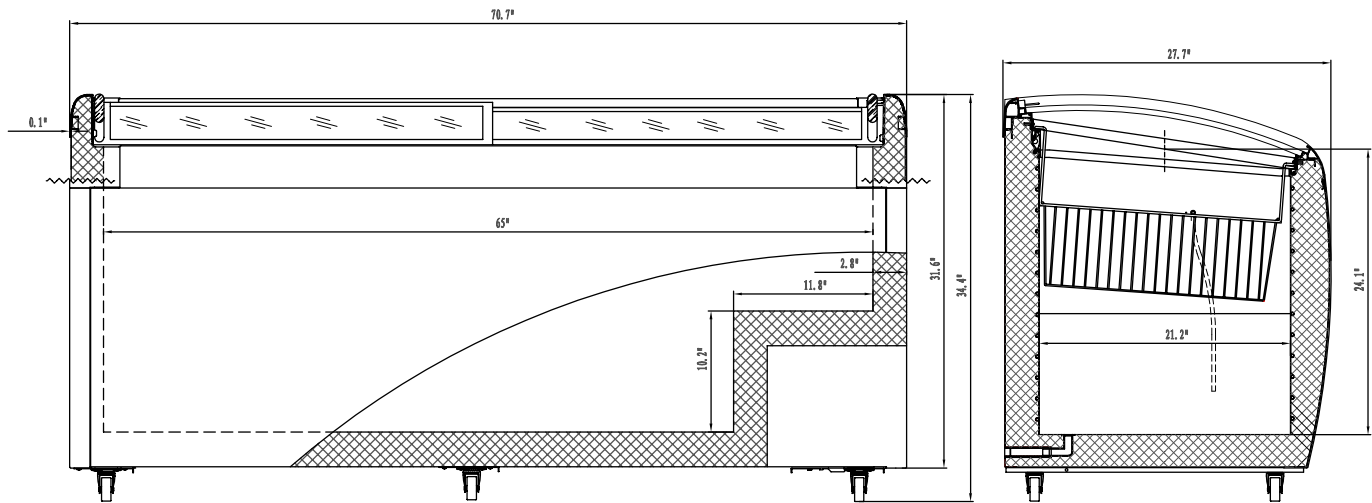

CERTIFICATIONS

ADA
COMPLIANT



706 Eastern Parkway STE 1G, Brooklyn NY 11213
718-576-6342
info@koolmore.com